

**HDD DVD RECORDER**

**GERUNDIG**

**GDR 5550 HDD**

**ENGLISH**

# CONTENTS

---

## 5-6

5  
5  
6

## HDD DVD recorder GDR 5550 HDD

Special features of your HDD DVD recorder  
Disc formats  
Scope of delivery

## 7

### Set-up and safety

## 8-17

8-9  
10  
11  
12  
13-14  
15-17

### Overview

The main functions  
Menus and navigation  
The front of the HDD DVD recorder  
The displays of the HDD DVD recorder  
The back of the HDD DVD recorder  
The remote control

## 18-24

18  
19-21  
22  
23

### Connection and preparation

Connecting a rooftop antenna or cable feed  
Connecting a television  
Connecting an audio system with analogue two-channel stereo sound  
Connecting a digital multi-channel amplifier or digital two-channel audio system  
Connecting the power cord  
Inserting batteries in the remote control

## 25-27

25  
25-26  
26  
27  
27

### Initial setup

Switching on the HDD DVD recorder  
Initial setup  
Sorting television stations  
Setting the TV norm  
Selecting the screen format of your television set

## 28-31

28-29  
30  
31  
31

### Time shift functions

Time shift – watching a current television programme with a delay  
Watching programmes with a time shift  
Searching for scenes in the time shift memory  
Copying sections of the programme stored in the time shift memory into the HDD archive

## 32-44

32  
32  
32  
33-34  
34  
35-36  
37-40  
41-43  
44

### Disc playback

Preparation  
Inserting discs  
Removing discs  
DVD playback  
DVD+RW/+R/-RW/-R playback  
S-VCD/VCD playback  
Playing audio and video files  
Picture data CD playback  
Audio CD playback

## 45-47

45  
45-46  
47

### HDD archive playback

Preparation  
Playback  
Selecting and playing scenes

## 48-51

48  
48  
48

### Disc playback – convenience functions

Selecting titles and chapters  
Selecting functions in the playback menu  
Pausing and resuming playback

# CONTENTS

---

49  
49  
49  
49  
49  
50  
50  
50  
51  
51

Frame search  
Slow motion  
Frame-by-frame playback  
Selecting camera angles for scenes  
Enlarging and moving a screen section (zoom)  
Switching the dubbed language or the audio format  
Selecting and displaying subtitles  
Creating and playing a playlist  
Repeating a chapter, a title or a disc  
Repeating a selected section (A-B Repeat)

## 52-54

52  
52  
52  
52  
53-54

## Recording – general information

Recording options  
Suitable discs for recording  
Unsuitable discs  
Initialising discs  
Recording quality and time

## 55-56

55  
55-56  
56  
56

## Recording on disc

Preparing for recording  
Manually recording television programmes  
Finalising a disc (DVD+R/-R/-RW)  
Error messages

## 57

57  
57

## YesDVD function

Activating and deactivating the YesDVD function  
Executing the YesDVD function

## 58

58  
58

## Recording on the HDD archive

Preparing for recording  
Manually recording television programmes

## 59-61

59  
60  
61

## Simultaneous operating modes

Recording on the HDD archive and simultaneous playback from the HDD archive  
Recording on the HDD archive and simultaneous playback from disc  
Recording on disc and simultaneous playback from the HDD archive

## 62

## Copying

## 63-66

63-65  
65  
66

## Timer recordings

Programming recordings by entering the data for the television programme  
Messages during or after programming a recording  
Checking, modifying or deleting recording data

## 67-76

67-69  
70  
71  
71-72  
72  
73  
73-74  
74  
75  
75  
76  
76

## Editing data on a disc

Editing titles  
Editing the names of recordings  
Deleting titles (recordings) from the disc  
Overwriting titles  
Overwriting discs  
Entering the name of the disc  
Deleting the content of the disc (DVD+RW/-RW)  
Recording titles  
Finalising title editing  
Locking a disc  
Finalising a disc (DVD+R/-R/-RW only)  
Deleting the content of the disc (DVD+RW/-RW)

# CONTENTS

---

## 77-83

77

77

78

78

78-81

82

82

83

## 84-85

84

85

## 86-87

86

87

## 88-90

88

89

89

90

## 91

91

91

## 92-93

92

92

93

## 94-96

94

95

95

96

96

96

## 97-100

97

97-98

99

99

100

100

## 101-106

101

102

103-104

105

106

## Editing data on the HDD archive

Preparation

Copying a title to disc

Deleting titles in the HDD archive

Sorting titles in the HDD archive

Functions in the HDD archive sub-menu

Viewing information via the HDD archive

Organising the hard disc

Deleting data in the HDD archive

## Copying

Connection and preparation

Recording from external devices

## Operation with a decoder

Connection and preparation

Recording pay TV programmes

## USB mode

Connection and preparation

Playing content from external data devices

Creating and playing back a playlist

Copying content from external data devices to disc

## Parental lock

Authorising the content of a DVD

Changing the access code (password)

## Audio settings

Selecting the digital output

Setting the sampling rate

Switching the dynamic range (volume range) on and off

## Custom settings

Language settings

Switching the screen saver on and off

Setting the signal type for the video output socket

Inserting chapter markers in the recordings

Selecting the recording quality

Selecting the input source for recording

## Special settings

Tuning television channels automatically

Tuning television channels manually

Setting the time and date

Switching the HDD DVD recorder to another Grundig remote control

DivX<sup>®</sup>Video registration

Resetting the HDD DVD recorder to its original condition

## Information

Technical data

General information on laser devices

Troubleshooting

Environmental note, cleaning discs, software information

Additional information for units sold in the UK.

# HDD DVD RECORDER GDR 5550 HDD

## Special features of your HDD DVD recorder



Your HDD DVD recorder provides you with perfect digital video recording and playback in studio quality.

You can record television programmes on the built-in hard disc of the HDD DVD recorder, a DVD+RW/-RW or DVD+R/-R.



With the time shift function you can watch television programmes with a time shift which are stored in the time shift memory. You can stop these programmes and continue playback at the same point.



It also provides superb cinema-quality audio playback – in stereo or with digital multi-channel sound – depending on the type of disc and audio system or stereo television.



Other features of DVD video include the choice of audio channel and language, choice of subtitle language, and various camera recording angles. Your HDD DVD recorder is suitable for DVDs with regional code 2.



In addition to DVDs the device can also play back DivX® Video CDs, MP3 CDs, video CDs, S-Video CDs, JPEG (photo) CDs, KODAK Picture CDs, WMA CDs and audio CDs.

DivX®, MP3, WMA and JPEG data can be played back from both CD-ROM and DVD-ROM.

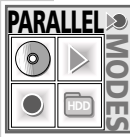

## Disc formats



DVD+RW/-RWs and DVD+R/-Rs are suitable for recording and playback. DVD video, DVD+RW/-RW, DVD+R/-R, audio CD, video CD, Super Video CD, CD-R and CD-RW are all suitable playback formats.



Due to the difference in quality of the recording media and the quality of the recording itself, it can occasionally happen that some recorded DVDs or CDs cannot be read. This does not indicate a malfunction on the part of the HDD DVD recorder.

You must finalise your own recordings on DVD+R/-R so that they can be played on a DVD player.

When MP3 CDs are played back, individual tracks or pictures may be skipped or incorrectly played back. This can be due to the disc configuration, the encoder software or the hardware used for the recording.

Audio CDs (CD-DA) meet the specification and bear the corresponding logo. Copy-protected CDs do not meet this specification and do not bear the logo. These CDs can cause playback errors.



# HDD DVD RECORDER GDR 5550 HDD

## Scope of delivery

- 1 HDD DVD recorder GDR 5550 HDD
- 2 Remote control
- 3 2 batteries, 1.5 V, type AA
- 4 EURO-AV (SCART) cable
- 5 Power cord
- 6 Antenna cable
- 7 Cinch cable (video)
- 8 Cinch cable (audio)
- 9 DVD+RW
- 10 CD with operating instructions
- 11 Instruction manual
- 12 Overview

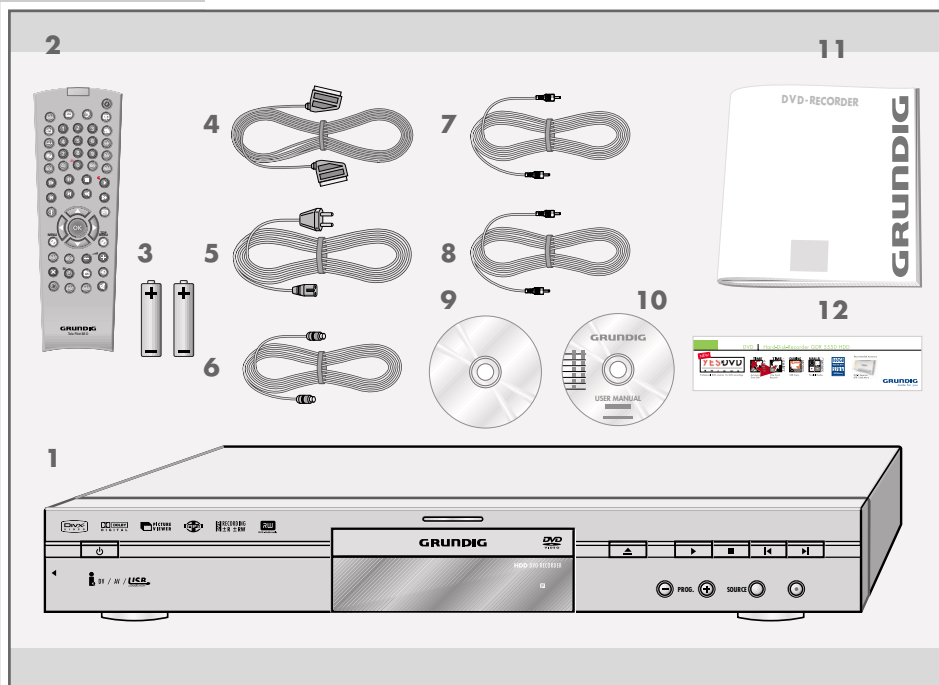

## SET-UP AND SAFETY

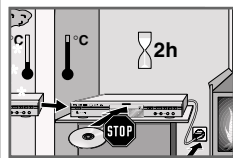

This HDD DVD recorder is designed to record and play back video and audio signals.

Any other use is expressly prohibited.

If the HDD DVD recorder is subjected to a sudden change in temperature, for example if it is brought in from the cold to a warm room, connect it to the mains supply and let it stand for at least two hours before you use it.

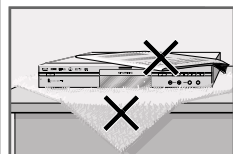

The HDD DVD recorder is designed for use in dry rooms. If you do use it in the open, please ensure that it is protected from moisture, such as rain or water splashes.

Place the HDD DVD recorder on a hard, level surface. Do not place any objects such as newspapers on the HDD DVD recorder, or any cloth or similar items underneath it.

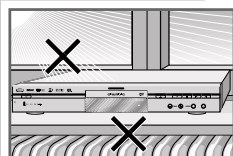

Do not place the HDD DVD recorder directly on top of an AV receiver or a subwoofer. Do not put any other appliances on top of the HDD DVD recorder. The laser optics are sensitive to temperature and shocks.

Do not place the HDD DVD recorder close to heating units or in direct sunlight, as this will impair cooling.

Do not insert objects in the disc compartment of the HDD DVD recorder.

Never open the HDD DVD recorder casing under any circumstances. No warranty claims are accepted for damage caused by incorrect handling.

Do not place any vessels filled with liquid, such as vases, on the HDD DVD recorder, as they may spill liquid, thus presenting a safety risk.

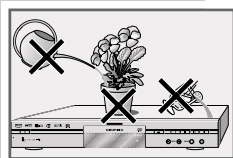

Thunderstorms are a danger to all electrical devices. Even if the HDD DVD recorder is switched off, it can be damaged by a lightning strike to the mains. Always disconnect the mains and antenna plugs during a storm.

If the HDD DVD recorder fails to read a DVD or CD properly, clean the disc with a soft cloth. Wipe the disc from the centre outwards. Do not use cleaning CDs to clean the laser optics. This can damage the optics.

Always keep the disc compartment of the HDD DVD video recorder closed to prevent dust from collecting on the laser optics.

Please note when deciding where to put the device that furniture surfaces are covered by various types of lacquer and plastic, most of which contain chemical additives. These may cause corrosion to the feet of the device, thus resulting in stains on the surface of the furniture which can be difficult or impossible to remove.

### Note:

Do not connect any other equipment while the device is switched on. Switch off the other equipment as well before connecting it.

Only plug the device into the mains socket after you have connected the external devices and the antenna.

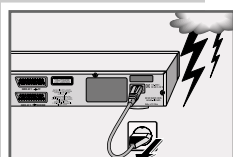

# OVERVIEW

---

## The main functions

This section briefly describes the main functions of your HDD DVD recorder.



### **Time shift – watching a current television programme with a delay** (from page 28)

When you switch on the HDD DVD recorder, the programme you are currently watching is recorded in the time shift memory. This memory has space for around 3 hours of recordings. After this time the oldest recording is deleted and the new scenes are recorded.

### **Disc playback** (from page 32)

You can play back DVDs as well as DivX<sup>®</sup> Video CDs, MP3 CDs, video CDs, S-Video CDs, JPEG (photo) CDs, KODAK Picture CDs, WMA CDs and audio CDs.

DivX<sup>®</sup>, MP3, WMA and JPEG data can be played back from both CD-ROM and DVD-ROM.

### **HDD archive playback** (from page 45)

Manually started recordings or timer recordings which are stored on the hard disc can be played back.

We recommend making a back-up copy of programmes that you wish to keep permanently on DVD+RW/-RW or DVD+R/-R.

### **Recording on the HDD archive** (from page 58)

Select the television channel or an external input source and start recording. The television programme is stored in the HDD archive.

### **Recording on discs** (from page 55)

DVD+RW/-RWs and DVD+R/-Rs are suitable for recording.

Due to the difference in quality of the recording media and the quality of the recording itself, it can occasionally happen that a recorded DVD cannot be read. This does not indicate a malfunction on the part of the HDD DVD recorder.

You must finalise your own recordings on DVD+R/-R so that they can be played on a DVD player.



# OVERVIEW

## The YesDVD function (from page 57)

The YesDVD function allows you to make professional home videos from your recordings.

At the end of recording, the HDD DVD recorder automatically creates a chapter overview, which is displayed as thumbnail images in the disc menu.

Using a PC, you can then create a sleeve cover for the disc.

Only the DVDs that have been automatically finalised are suitable for this function.

This function cannot be used for the USB and HDD archive input sources.

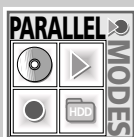

## Recording on the HDD archive and simultaneous playback from the HDD archive (from page 59)

You can record on the HDD archive and simultaneously play back a title from it.

## Recording on the HDD archive and simultaneous playback from a disc (page 60)

Select HDD archive recording mode to record programmes in the HDD archive. At the same time, you can play back a title from the disc.

## Recording on disc while playing back from the HDD archive (page 61)

Select disc recording mode, select the television channel or external input source and start recording. The recording is stored on the disc. At the same time, you can choose a title from the HDD archive and play it back.

## Copying from the HDD archive to disc (page 62)

You can quickly create a back-up by copying the data from the HDD archive to disc.

## Copying from the USB input to disc (page 90)

Connect a digital camera or memory stick to the USB input and copy the data to disc.



## Timer recording on a disc or the HDD archive (from page 63)

Open the timer menu and enter the data for the television programme you want to record. Recording starts at the time you select. The television programme is stored on disc or in the HDD archive.

# OVERVIEW

## Menus and navigation

You can access the various menus of your HDD DVD recorder directly using the main menu, or with individual buttons on the remote control.

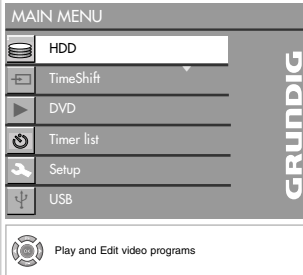

1 Open the »MAIN MENU« of the HDD DVD recorder by pressing »i«.

2 Press »▼« or »▲« to select the menu item.



»HDD« – switches to the HDD archive.

You can also open the menu directly by pressing »« (yellow).



»TimeShift« – switches to time shift mode.



»DVD« – switches to the contents menu of the disc.



»Timer list« – switches to the timer menu where you can programme up to eight recordings.

You can also open this menu directly by pressing »« (green).



»Setup« – you can use this menu to make various device settings.

You can open this menu directly by pressing »**SET UP**«.



»USB« – opens the file browser when you connect an external data device to the USB interface.

You can also open the file browser directly by pressing »**SELECT**«.



»Edit« – in this menu you can edit the contents of a home-recorded disc.

If an external data device is connected to the USB interface, the copying menu »USB -> DVD« is displayed.

3 Press »OK« to activate the menu item.

4 Select individual menu options with »◀«, »▶«, »▼« or »▲« and press »OK« to confirm.









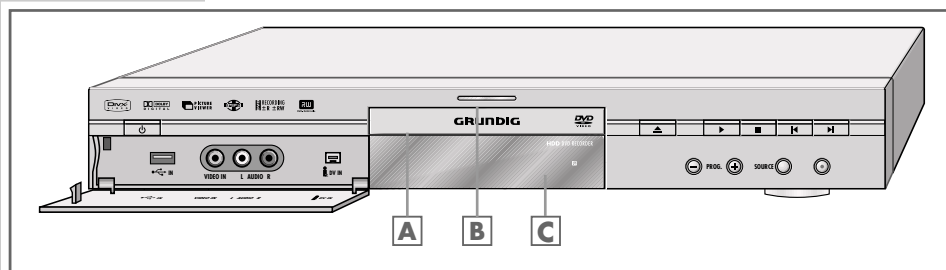







5 Press »« to exit individual menu options.

6 Press »i« to quit the main menu.

# OVERVIEW

## The front of the HDD DVD recorder



-  Switches the HDD DVD recorder in and out of standby mode.  
In standby mode, the current time and day of the week appear on the display.
-  **IN** USB interface for connecting an external data medium (under the cover panel).
- VIDEO IN** Video/audio input sockets for connecting a camcorder (under the cover panel).
- L AUDIO IN R**
- i DV IN** Video/audio input socket (Fire Wire IEEE 1394) for connecting a digital camcorder (under the cover panel).
-  **A** Compartment for disc media.
-  **B** Recording display.
-  **C** Display.
-  Opens and closes the disc compartment.
-  Starts playback.  
Confirms the options selected in the menus.
-  Interrupts playback and recording.  
Press twice to stop.  
Activates the selected menu.
-  During playback, press briefly to select the previous or next section.  
Move the cursor to the left or right in the menus.  
Hold down   to open the main menu.  
Move the cursor to the left or right in the menus.  
Press   to exit the selected menu.
- PROG +** Select TV channels -  down,  up.  
Move the cursor up and down in the menus.
- SOURCE** Selects input sources.
-  Starts recording. Press repeatedly to enter the switch-off time in 30 minute steps.

# OVERVIEW

## The displays of the HDD DVD recorder

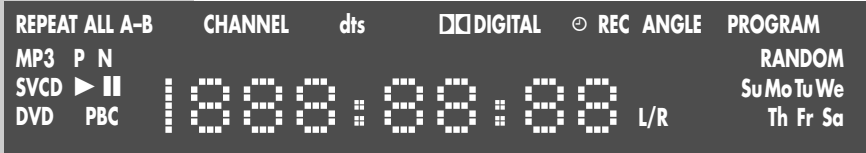

<b>REPEAT ALL REPEAT A-B</b>	Repeat functions activated.
<b>MP3</b>	Disc mode with MP3 CD.
<b>P N</b>	PAL or NTSC standard is selected.
<b>SVCD</b>	Disc mode with S-Video CD, video CD or audio CD.
<b>►</b>	Playback.
<b>  </b>	Pause/freeze-frame.
<b>DVD</b>	Disc mode with DVD.
<b>Hdd</b>	HDD mode.
<b>PBC</b>	PBC function (playback control) for S-Video CD or video CD is activated.
<b>CHANNEL</b>	Selected channel.
<b>dts DIGITAL</b>	Information on the type of audio signal.
<b>REC</b>	Recording.
<b>⌚</b>	Timer recording.
<b>ANGLE</b>	The DVD provides various camera angles.
<b>PROGRAM</b>	Function is activated.
<b>L/R</b>	Stereo audio signal selected.
<b>RANDOM</b>	Random function is activated.
<b>Su ... Sa</b>	Current day of the week.
<b>0000000</b>	Alphanumerical display for various information such as the title, chapter, playing time, etc.

# OVERVIEW

## The back of the HDD DVD recorder

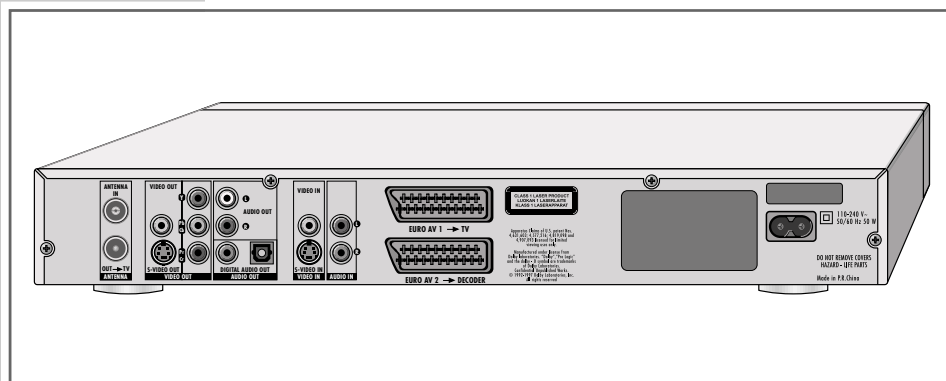

### ANTENNA

#### ANTENNA IN

Antenna input socket  
(for the rooftop antenna).

#### OUT → TV

Antenna output socket  
(to the television).

### VIDEO OUT

#### VIDEO OUT

Video output socket  
for connecting a television or AV receiver  
with a cinch socket.

#### S-VIDEO OUT

Video output socket  
for connecting a television or AV receiver  
with an S-Video socket.

#### Y Pb/Cb Pr/Cr

Video output sockets for connecting a  
television, flat screen or projector  
(YUV standard).

### AUDIO OUT

#### L AUDIO OUT R

Audio output sockets (left/right analogue  
channel) for connecting an audio system.

#### DIGITAL AUDIO OUT

Audio output sockets (coaxial)  
for PCM/Dolby digital/DTS signals.  
For connecting to a digital multi-channel  
audio/video amplifier or AV receiver.

Audio output sockets (optical) for  
PCM/Dolby digital/DTS signals.  
For connecting to a digital multi-channel  
audio/video amplifier or AV receiver.

# OVERVIEW

---

## VIDEO IN

### VIDEO IN

Video input socket for connecting a video recorder, DVD player or AV receiver with a cinch socket.

### S-VIDEO IN

Video input socket for connecting an SVHS-video recorder or AV receiver with an S-VIDEO socket.

## AUDIO IN

### L R

Audio input sockets (left/right analogue channel) for connecting a video recorder, DVD player or an audio system.

### EURO AV1 → TV

Euro-AV (SCART) socket (input/output) for the television.

### EURO AV2 → DECODER

Euro/AV (SCART) socket (input/output) for an external device.

### AC 110-240V~ 50/60 Hz 50W max.

Power cord socket.

#### **Caution:**

Do not connect any other equipment while the device is switched on. Switch off the other equipment as well before connecting it.









Only plug the device into the mains socket after you have connected the external devices and the antenna.

Never touch the inside of the sockets and plugs of the connecting cables. Electrostatic discharge can damage the HDD DVD recorder.

# OVERVIEW

## The remote control





-  Switches the HDD DVD recorder in and out of standby mode.  
In standby mode, the current time and day of the week appear on the display.
- DISPL**  Opens the time shift menu or the playback menu of a disc.
-  For selecting and displaying subtitles\* on the DVD during playback.
-  Switches between the original and dubbed language\* during DVD playback.  
Switches between the various sound formats.
-  Zooms in on scenes\* during playback.
-  For setting bookmarks\*.
- 1 ... 0** Numerical buttons for entering various data.  
»0« Selects programme sources.
-  Selects a search by title, chapter or time.
-  Selects various repeat functions.
- A-B** For marking selected sections\* for repeated playback.
- CL** Deletes a programmed timer recording.  
Adds and deletes chapters and sections in the playlist.
- RND** Selects the RANDOM PLAY\* function.
- PROG** Selects the playlist\*.
- DV** Switches to the »DV« (Digital Camera) input source.
- I/P** When stopped: Switches the video signal between progressive and interlace mode. In the "SCART output" menu, the video output must be set to "YUV".
-  Selects various camera angles\* for certain scenes or passages on the DVD during playback.

\* Depends on the disc in use.

# OVERVIEW



- ▶ Switches to forwards slow motion\* at various speeds during playback.
- ▬ Freeze-frame/pause.  
Advances the picture frame by frame.
- Interrupts playback.  
Press twice to stop.  
Hold down to open the disc compartment.
- ▶ Starts playback.
- ◀ ▶ Select the previous/next chapter or section during playback.
- ◀◀ ▶▶ Switch to forwards or reverse picture search at various speeds during playback.
- i Opens the main menu for the HDD DVD recorder.
- ▲ ▼ ◀ ▶ Select various functions in the menus.  
Select TV channels, » ▼ ◀ down, » ▲ ◀ up.
- OK** Press once to display various information on the television screen during playback.  
Press twice to display the playback menu.  
Confirms selected options in menus.
- ◀ Switches up one menu level.
- MENU**  Opens the disc menu\* of a DVD during playback.  
Switches from time shift mode to disc mode.  
Switches from HDD archive to disc mode.
- TOP MENU**  Closes the disc compartment.  
Opens the title menu\* of the DVD during playback.  
Switches from time shift mode to disc mode.  
Switches from HDD archive to disc mode.



# OVERVIEW



**SELECT** Switches between external USB source and HDD archive.

**SET UP** Opens and closes the setup menu of the HDD DVD recorder.

-  + Adjust the volume.

 (red) Selects different functions depending on the mode.

 (green) Selects different functions depending on the mode.

 (yellow) Selects different functions depending on the mode.

 (blue) Selects different functions depending on the mode.

 Starts the recording and sets the switch-off time (in 30 minute steps).  
Marks a starting point in time shift mode.

**Q-SET** Selects the recording quality.

**SOURCE** Selects input sources.

 Switches the HDD DVD recorder to and from mute during playback.

# CONNECTION AND PREPARATION

## Note:

Do not connect any other equipment while the device is switched on. Switch off the other equipment as well before connecting it. Only plug the device into the mains socket after you have connected the external devices.

## Connecting a rooftop antenna or cable feed

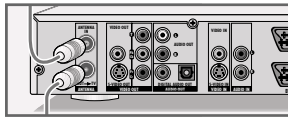
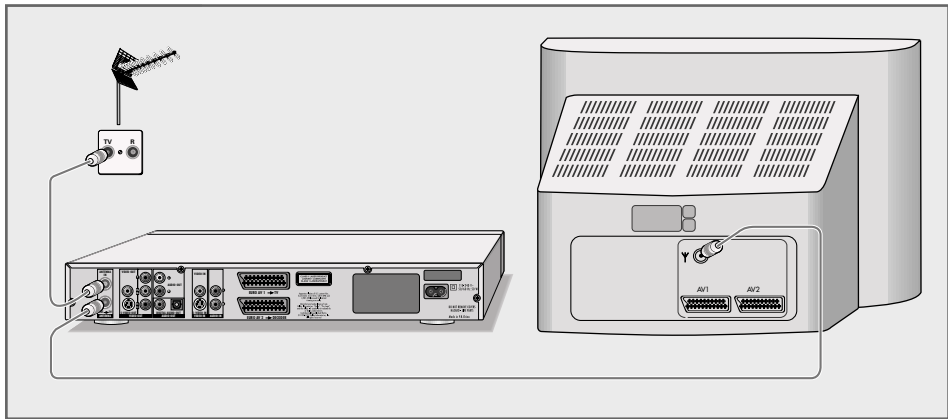

- 1 Plug the cable of the rooftop antenna or cable feed into the antenna socket »**ANTENNA IN**« on the HDD DVD recorder.
- 2 Plug the antenna cable into the »**OUT → TV**« socket on the HDD DVD recorder and the antenna socket on the television set.

# CONNECTION AND PREPARATION

## Connecting a television

You have four options, depending on the sockets you have on your television or flat screen:

- For the best picture quality, make the connection at the EURO-AV socket using a fully assigned EURO-AV (SCART) cable.
- The simplest option which still offers sufficient quality is to connect the VIDEO OUT socket and AUDIO OUT sockets using cinch cables.
- The standard connection for many devices, and one which provides good quality, is via the S-VIDEO OUT socket and the AUDIO OUT cinch sockets.
- Connection via the cinch sockets Y, Pb/Cb and Pr/Cr (video signals) and the AUDIO OUT cinch sockets (audio signals). This connection (progressive scan) can also be used for projectors.

Connect the HDD DVD recorder directly to the television. If you connect a video recorder in between, the HDD DVD recorder's copy protection may impair the picture quality.

## Connecting a television using a EURO-AV (SCART) cable

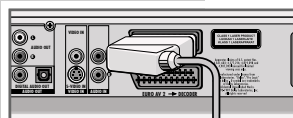
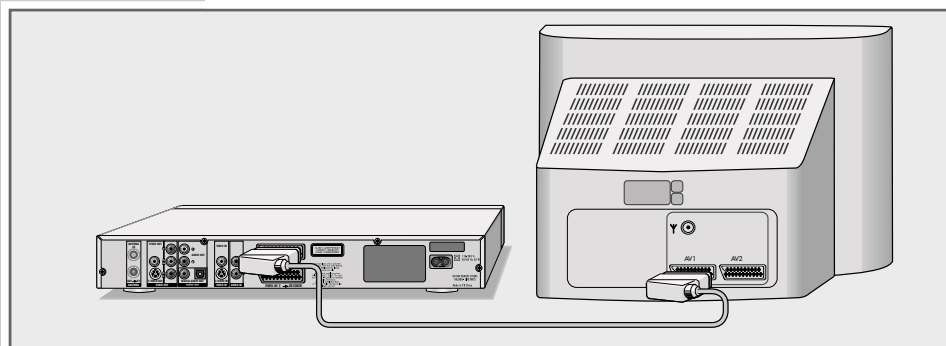

- 1 Plug the EURO-AV cable supplied into the »EURO AV1 → TV« socket on the HDD DVD recorder and into the corresponding socket on the television.

# CONNECTION AND PREPARATION

## Connecting a television using cinch cables

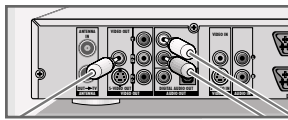
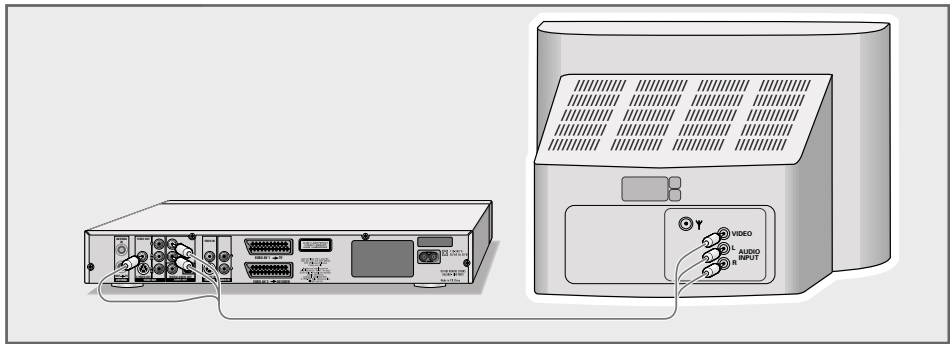

- 1 Plug the cinch cable supplied into the **»VIDEO OUT«** socket on the HDD DVD recorder and the corresponding socket (VIDEO IN) on the television.
- 2 Plug standard cinch cables into the **»L AUDIO OUT R«** sockets on the HDD DVD recorder and the corresponding sockets (AUDIO IN) on the television.

## Connecting a television using a Y/C (S-VIDEO) cable and cinch cables

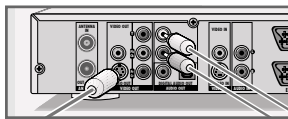
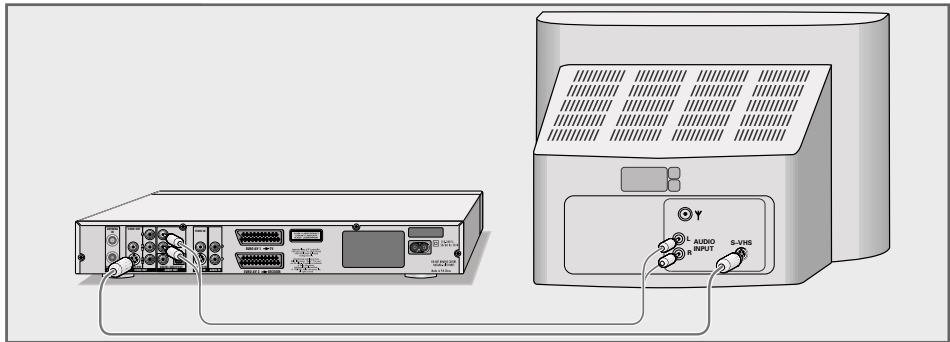

- 1 Plug the standard S-Video cable into the **»S-VIDEO OUT«** socket on the HDD DVD recorder and the corresponding socket (S-VHS IN) on the television.
- 2 Plug standard cinch cables into the **»L AUDIO OUT R«** sockets on the HDD DVD recorder and the corresponding sockets (AUDIO IN) on the television.

# CONNECTION AND PREPARATION

## Connecting a television using cinch cables (progressive scan)

### Caution:

This connection transmits video signals at a high frequency range. Before you first switch on the device, please check whether your television or projector is suitable for this use.

GRUNDIG accepts no liability for damage resulting from negligent use.

### Notes:

The video output must be set to »YUV« under »SETUP« -> »PREFERENCES« -> »Video Output«.

You can use the »I/P« button to select whether the video signal is provided in progressive mode or interlace mode.

Depending on the model of television or projector, you have to activate the relevant input sockets on the device.

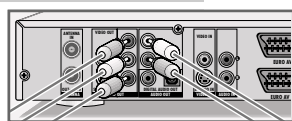
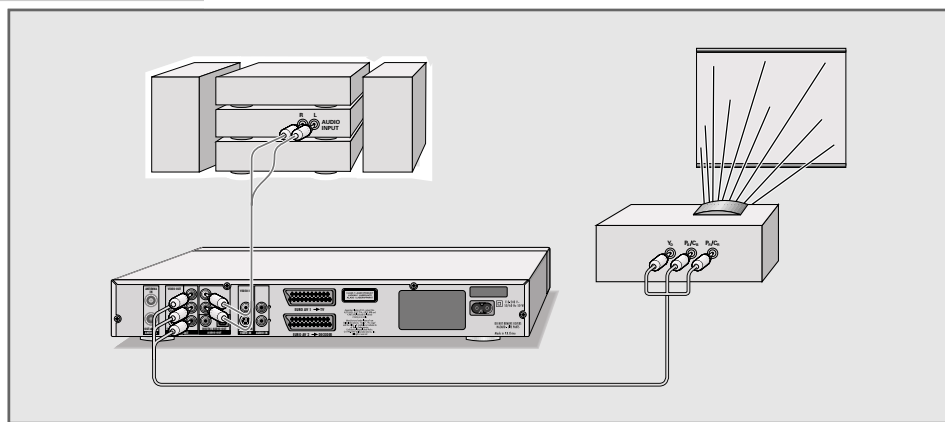

- 1 Plug a standard cinch cable in the »Y«, »Pb/Cb« and »Pr/Cr« sockets of the HDD DVD recorder and in the corresponding socket (e.g. VIDEO IN or COMPONENT Y Pb/Cb Pr/Cr) on the television or projector.
- 2 Plug standard cinch cables into the »L AUDIO OUT R« sockets on the HDD DVD recorder and in the corresponding sockets (AUDIO IN) on the television or projector.

# CONNECTION AND PREPARATION

## Connecting an audio system with analogue two-channel stereo sound

As an alternative to using the television's speakers, the sound can also be played back through an audio system. This can improve the sound quality.

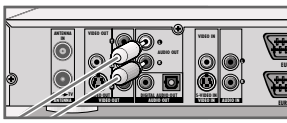
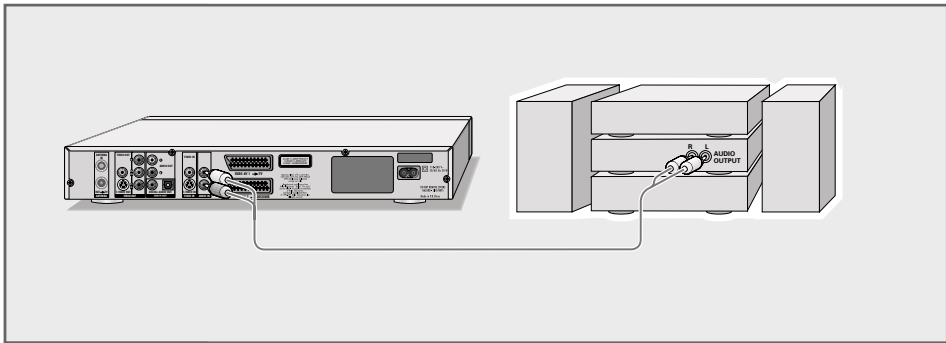

- 1 Plug a standard cinch cable into the »L AUDIO OUT R« socket on the HDD DVD recorder and the corresponding sockets on the audio system.

**Caution:**

Do not connect the »L AUDIO OUT R« sockets on the HDD DVD recorder to the PHONO (record player) input socket on the audio system.

# CONNECTION AND PREPARATION

## Connecting a digital multi-channel amplifier or digital two-channel audio system

A multi-channel audio/video amplifier (Dolby\* digital decoder or DTS\*\* – Digital Theatre System) decodes the digital multi-channel sound of the DVD to provide optimum sound quality.

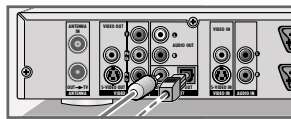
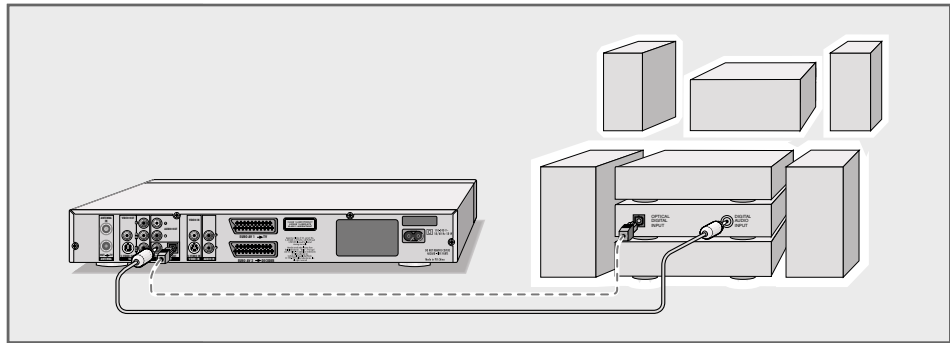

- 1 Plug the cinch cable supplied into the cinch socket »**DIGITAL AUDIO OUT**« (coaxial) on the HDD DVD recorder and into the corresponding socket on the digital multi-channel amplifier;  
or

plug a standard optical cable into the »**DIGITAL AUDIO OUT**« socket (optical) on the HDD DVD recorder and the corresponding socket on the digital multi-channel amplifier.

### Note:

Even if you are using a digital connection, you should still make an analogue audio connection (see page 22) because depending on the disc type, the »**DIGITAL AUDIO OUT**« socket may not be able to transfer the signal.

\* Manufactured under licence from Dolby Laboratories Licensing Corporation. "Dolby", "Dolby Pro Logic", "Dolby Digital" and the double-D symbol "DD" are trademarks of the Dolby Laboratories Licensing Corporation. Copyright 1992 Dolby Laboratories, Inc. All rights reserved.

\*\* DTS and DTS Digital Out are trademarks of Digital Theatre Systems, Inc. All rights reserved.

# CONNECTION AND PREPARATION

## Connecting the power cord

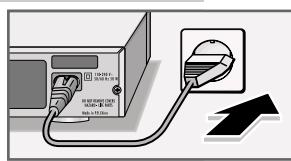

- 1 Plug the mains cable supplied into the »110-240V~« socket on the back of the HDD DVD recorder.
- 2 Plug the power cord into the wall socket.

### Caution:

The only way to disconnect the HDD DVD recorder from the mains is to pull out the plug.

### Note:

Do not connect any other equipment while the device is switched on. Switch off the other equipment as well before connecting it.

Only plug the device into the mains socket after you have connected the external devices and the antenna.

## Inserting batteries in the remote control

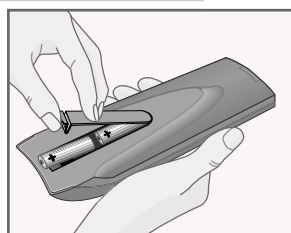

- 1 To open the battery compartment, press the catch and remove the lid.
- 2 When inserting the batteries (Mignon type, e.g. R06 or AA, 2 x 1.5 V), observe the polarity marked on the battery compartment.
- 3 Close the battery compartment.

### Note:

If the HDD DVD recorder no longer reacts properly to remote control commands, the batteries may be flat. Always remove used batteries. The manufacturer accepts no liability for damage resulting from leaking batteries.



### Environmental note:

Batteries, including those which contain no heavy metal, should not be disposed of with household waste. Please dispose of used batteries in an environmentally responsible manner. Find out about the legal regulations which apply in your area.



# INITIAL SETUP

## Switching on the HDD DVD recorder

- 1 Switch the HDD DVD recorder to standby mode by pressing »« on the device and press »« on the remote control to switch on from standby.  
– Display: »HELLÖ« flashes.

## Initial setup

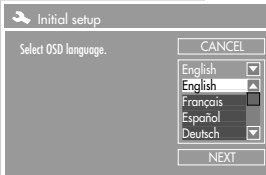

When you first switch on the HDD DVD recorder, the »Initial setup« menu always appears.

This guides you step by step through each setting.



### Selecting the screen menu language



This is how to set the language of the HDD DVD recorder's screen menus.

- 1 Select your language using »« or »« and press »**OK**« to confirm.
- 2 Select »NEXT« by pressing »**OK**«.



### Selecting the country (location)



This setting determines the sort order of the TV stations.

- 1 Press »« or »« to select the country and press »**OK**« to confirm.
- 2 Select »NEXT« by pressing »**OK**«.

## Tuning television stations

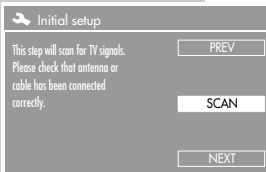
The HDD DVD recorder has its own receiver unit. It can receive and record from television stations independently of the television. This means the TV channels have to be tuned on the HDD DVD recorder. During this setting, the clock is automatically updated. However, this is only possible if you find a television station with teletext and valid time information.



- 1 Select »SCAN« with »« or »« and press »**OK**« to start the search.  
– The HDD DVD recorder searches all channels for television stations, then sorts and saves them. The automatic search may take several minutes.
- 2 Select »NEXT« by pressing »**OK**«.

## Setting the time and date

- 1 If the time and date are correct, select »NEXT« »**OK**« to confirm.

# INITIAL SETUP

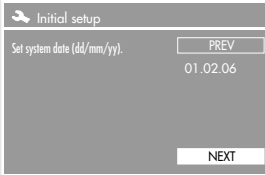

## Entering a new time and date

- 1 Select the date line with »▼« or »▲« and press »OK« to activate it.
- 2 Enter the date as six digits using »1...0« and press »OK« to confirm the setting.
- 3 Select »NEXT« by pressing »OK«.
- 4 Select the time line with »▼« or »▲« and press »OK« to activate it.
- 5 Enter the time as six digits using »1...0« and press »OK« to confirm the setting.
- 6 Select »NEXT« by pressing »OK«.



## Ending initial setup

- 1 Select »FINISHED« by pressing »OK«.  
– Initial setup is complete.

## YesDVD information

- 1 Information about the YesDVD function appears. Press »OK« to switch off the display.

## Sorting television stations

You can sort the TV stations in any order you like.

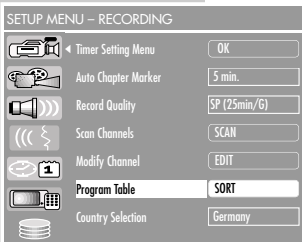

- 1 Press »SET UP« to open the setup menu.
- 2 Select »SETUP-MENÜ – RECORDING« ( ) with »▼« or »▲« and press »OK« to confirm.
- 3 Select »Program Table« with »▼« or »▲« and press »OK« to confirm.
- 4 Press »OK« to confirm the message.  
– The »Sort« menu appears.
- 5 Press »▼« or »▲« to select the station to move and mark it with »►«.
- 6 Select a new preset with »▼« or »▲« and then press »OK« to confirm.
- 7 Press »◀« to move to »OK« and press »OK« to confirm the setting.  
**Note:**  
To sort the other television channels, repeat steps 3 to 7.
- 8 Press »SET UP« to complete the setting.

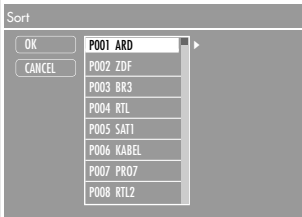

# INITIAL SETUP

## Setting the TV norm

The colour norm of the HDD DVD recorder's screen menus has to be adapted to the format of your television.

Select »PAL« for televisions with the PAL standard, or »NTSC« for those with the NTSC standard.

»PAL« is the default setting.

- 1 Press »**SET UP**« to open the setup menu.
- 2 Select »SETUP-MENU – VIDEO« (  ) with »▼« or »▲« and press »**OK**« to confirm.
- 3 Select »Default TV system« using »▼« or »▲« and press »**OK**« to activate it.
- 4 Select the setting (»NTSC« or »PAL«) with »▼« or »▲« and press »**OK**« to confirm.
- 5 Press »**SET UP**« to finish the setting.

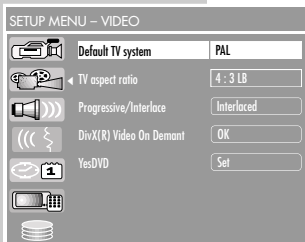

## Selecting the screen format of your television set

This setting depends on your television, and on the information on the DVD.

If you have a 4:3 format television, the following settings are available:

»4:3 P&S« for wide-screen playback, with the left and right edges of the picture cropped (depending on the DVD used).

or »4:3 LB« for wide-screen playback with black bars on the top and bottom edges of the screen.

If you have a 16:9 format television, select the »16:9« setting.

»4:3 LB« is the default setting.

- 1 Press »**SET UP**« to open the setup menu.
- 2 Select »SETUP-MENU – VIDEO« (  ) with »▼« or »▲« and press »**OK**« to confirm.
- 3 Select »TV aspect ratio« with »▼« or »▲« and press »**OK**« to activate it.
- 4 Select the picture format (»4:3 LB«, »4:3 P&S« or »16:9 WS«) with »▼« or »▲« and press »**OK**« to confirm.
- 5 Press »**SET UP**« to finish the setting.

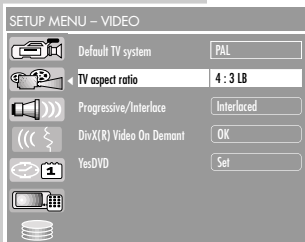

# TIME SHIFT FUNCTIONS

## Time shift – watching a current television programme with a delay

When you switch on the HDD DVD recorder, the current programme that you can see on the television screen is recorded in the time shift memory.

If a digital receiver is connected to the HDD DVD recorder, select SETUP MENU → PREFERENCES → Default Source → EURO-AV 2. The signal of the digital receiver is then recorded in the time shift memory.

The time shift memory has space for up to 3 hours of recordings, which means that after 3 hours of recording, the HDD DVD recorder continues recording but the start of the recording is lost.

The data in the time shift memory can be partially or completely copied into the HDD archive at any time.

### The time shift menu

When you switch on the HDD DVD recorder, the time shift menu is displayed briefly.

The time shift menu can be hidden and displayed again with »DISPL« or »OK«.

Press »DISPL« twice to hide the dialog line and buttons.

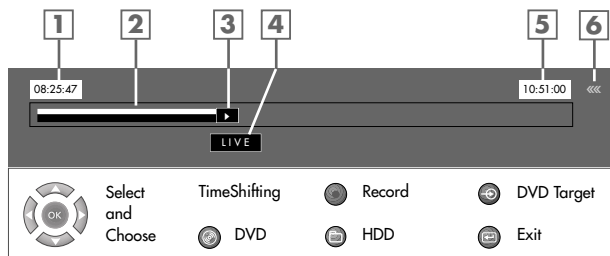

- 1 Start of time shift recording (earliest possible playing position).
- 2 Visual display of the time shift memory.
- 3 Current playing position.
- 4 »LIVE« indicates that you are watching the programme without a time shift.  
If you rewind the programme, the display shows the playing position of the current scene.
- 5 Current time.
- 6 Animated symbol for recording in the time shift memory.

# TIME SHIFT FUNCTIONS

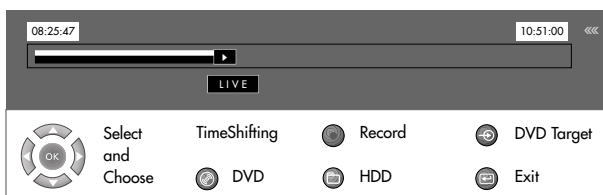

## 7 Dialog line with buttons and their functions.



» ▲ « or » ▼ « select the television station or the AV channel to be recorded in the time shift memory.



» ◀ « or » ▶ « select scenes from the time shift recording.

» ◀ ◀ 10 seconds backwards.

» ▶ ▶ 10 seconds forwards.

TimeShifting

Operating mode display.



Switches to disc playback; the time shift recording is continued in the background.



The programme is being recorded in the HDD archive.



Switches to the HDD archive; the recording in the time shift memory is continued.



Switches to disc recording mode; the time shift recording is ended.

The programme can then be recorded on disc.



Switches the time shift menu off.

# TIME SHIFT FUNCTIONS

## Watching programmes with a time shift



- 1 When you switch on the HDD DVD recorder, the current programme that you can see on the television screen is recorded in the time shift memory.
  - The time shift menu is displayed briefly.

### Note:

You can view the time shift menu with »DISPL« or »OK«.

## Pausing a live programme

You can pause the programme you are watching. This is a useful function, for example, if the telephone rings while you are watching a film and you don't want to miss anything.

A freeze-frame display of the last scene appears on the screen and the programme is recorded in the time shift memory.

- 1 Press »|||« to pause the current programme.
  - The »LIVE« display disappears.
- 2 Press »▶« to continue the programme.
  - Instead of »LIVE« the relative playing position is shown. The time display in the right of the time shift menu shows the current time.

### Note:

Switch back to live recording by pressing »▶|« or »▶▶« repeatedly.

If you catch up with the scene currently being broadcast, »LIVE« appears again in the display.

### Note for operation with a digital receiver:

If the television programme is coming from a digital receiver (connected to the EURO AV2 socket) and you want to make the setting using the menu of the digital receiver, »LIVE« must be shown in the time shift menu. If not, then the settings in the menu of the digital receiver are displayed with a time shift.

## Repeating the last scene of the programme

- 1 By pressing »▶« you can repeat the last seven seconds of the programme.
  - Playback then continues with a time shift.
- 2 Switch back to live recording by pressing »▶|«.

# TIME SHIFT FUNCTIONS

## Searching for scenes in the time shift memory

You can search for scenes in the current recording. The programme continues to be recorded in the time shift memory.

- 1 By pressing »◀◀◀ you can “rewind” the programme. Three different speeds are available.
- 2 By pressing »|◀◀ you can switch back to the start of each chapter. (You can set the duration of each chapter in the setup menu.)
- 3 If you view past scenes in the time shift memory, you can “fast forward” the programme with »▶▶◀. Three different speeds are available.
- 4 If you view past scenes in the time shift memory, you can “fast forward” the programme in chapters with »▶|◀.

**Note:**

If »LIVE◀ is displayed, it is not possible to move any further forward in the programme.

## Copying sections of the programme stored in the time shift memory into the HDD archive

You can copy sections of the programme which are currently stored in the time shift memory into the HDD archive.

Note that the recordings in the time shift memory before the starting point marker and the selected section will be deleted from the time shift memory. The sections after the end point marker are retained.

- 1 Press »DISPL◀ or »OK◀ to open the time shift menu.
- 2 Using »◀◀◀, »◀◀◀ or »|◀◀ select the start of the scene that is to be copied.
- 3 Once you reach the start of the scene, mark the starting point with »●◀.
- 4 Using »▶◀, »▶▶◀ or »▶|◀ search for the end of the scene that is to be copied.
  - The section that is to be copied is marked red in the time shift menu.

**Note:**

The markings can be deleted with »CL◀.











- 5 Once you reach the end of the scene, mark the end point with »■◀.
  - The marked section is automatically copied into the HDD archive.
  - This section and the recordings before this section are deleted from the time shift memory.

# DISC PLAYBACK

## Preparation

- 1 Switch on the television and select the preset channel for the HDD DVD recorder.
- 2 If an audio system or an AV receiver is connected to the HDD DVD recorder, switch it on and select the audio input for the HDD DVD recorder.
- 3 Press  to switch on the HDD DVD recorder from standby mode.
  - Display: »HELLLO« flashes, followed by the channel position and the recording quality.

## Inserting discs

- 1 Briefly press  on the HDD DVD recorder or press and hold down  on the remote control.
  - Display: , the disc compartment opens.
- 2 Put a disc in the compartment with the label facing upwards.
- 3 Press  on the HDD DVD recorder or press and hold down  on the remote control.
- 4 Open the »MAIN MENU« of the HDD DVD recorder by pressing .
- 5 Select the  DVD« menu item with  or  and press  to confirm.  
or select disc mode with  directly.
  - Disc mode is selected.

### Notes:

You cannot operate the device as long as  LOADING« is showing in the display.

If a recorded DVD+RW/DVD+R is inserted, the index screen appears.



Select the title with , ,  or  and press  or  to start playback.

Playback of a DVD, VCD, S-VCD, MP3 CD, WMA CD or audio CD (CD DA) starts automatically.

If playback is not started automatically, start it by pressing .

If the  symbol appears on the television screen, the selected function is not possible with this disc.

## Removing discs

- 1 Press  on the HDD DVD recorder or press and hold down  on the remote control.
  - The disc compartment opens.



# DISC PLAYBACK



## DVD playback

### DVD features

You can recognise a DVD by the logo on the label.

Depending on the content of the DVD, the discs contain one or more titles.

Each title may contain one or more chapters.

You can control and direct playback of a DVD using the menu of the HDD DVD recorder on the television screen.

### Special DVD features

DVDs have a title menu which provides an overview of the available titles and the passages they contain.

Some of the HDD DVD recorder's functions, such as slow motion, freeze-frame and auto-play, can also be controlled by the DVD itself. Because of this you may not be able to select these functions during certain scenes.

Many DVDs have audio tracks recorded in up to eight languages. You can select the language you prefer.

Many DVDs are recorded by the manufacturer with subtitles in up to thirty-two languages. You can select the subtitles you prefer.

### Playback

- 1 Open the »MAIN MENU« of the HDD DVD recorder by pressing »i«.
- 2 Select the »▶ DVD« menu item with »▼« or »▲« and press »OK« to confirm.  
– Disc mode is selected.
- 3 When you select disc mode, playback starts automatically. If playback does not start automatically, press »▶«.

#### Notes:

Depending on the DVD you are using, you may have to select a title or chapter from its table of contents.

Press »▲«, »▼«, »◀« or »▶« to select the chapter or title and »▶« or »OK« to start playback.

If DVD access has not been authorised, you must change the access level code (1 to 8) (see the section on authorising the content of the DVD on page 91).

If the »« symbol appears on the television screen, then the selected function is not possible with this DVD.

- 4 Press »||« to pause playback (freeze-frame).

# DISC PLAYBACK

---

- 5 Advance frame-by-frame by pressing »**II**«.
- 6 Press »**▶**« to resume playback.
- 7 To stop playback, press »**■**« twice.

## Opening the playback menu

- 1 You can open the playback menu by pressing »**DISPL**« twice.
- 2 You can select repeat functions in »Mode«.

## DVD+RW/+R/-RW/-R playback

### Features of DVD+RW/+R/-RW/-R

You can recognise a disc by the logo on the label.

If programmes were recorded on these discs, your HDD DVD recorder can play them back.

If you want to play a DVD+R/-R on a DVD player, it must first be finalised.

### Playback

- 1 Open the »MAIN MENU« of the HDD DVD recorder by pressing »**i**«.
- 2 Select the »**▶ DVD**« menu item with »**▼**« or »**▲**« and press »**OK**« to confirm.  
– Disc mode is selected.
- 3 When you select disc mode, playback starts automatically if the disc is copy-protected or has been finalised.

#### Note:

If playback does not start automatically, press »**▲**« or »**▼**« to select the title you want from the index and »**OK**« to start playback.

- 4 Press »**II**« to pause playback (freeze-frame).
- 5 Advance frame-by-frame by pressing »**II**«.
- 6 Press »**▶**« to resume playback.
- 7 To stop playback, press »**■**« twice.



# DISC PLAYBACK



## S-VCD/VCD playback

### S-VCD/VCD features

You can recognise S-VCD/VCDs (video CDs) by the logo on the label.

Depending on the contents of the S-VCD/VCD (films, music videos etc.), the discs may carry one or more tracks.

You can create S-VCDs/VCDs using the PBC (playback control) system for track navigation. This depends on the editing and burning software used.

You cannot select some of the functions on the HDD DVD recorder (slow motion, camera angle, marking scenes) when you are playing an S-VCD/VCD. This depends on how the S-VCD/VCD was created.

### Playback

- 1 Open the »MAIN MENU« of the HDD DVD recorder by pressing »i«.
- 2 Select the »▶ DVD« menu item with »▼« or »▲« and press »OK« to confirm.  
– Disc mode is selected.
- 3 When you select disc mode, playback starts automatically.  
If playback is not started automatically, start it by pressing »▶«.  
– Display: Tracks and elapsed playing time.

#### Note:

Depending on the type of S-VCD/VCD used, you may have to press »▶|« or »|◀« or »1...0« to select the disc title from a list. Press »◀« to switch back to the previous menu with PBC ON.

- 4 Press »||« to pause playback (freeze-frame).
- 5 Advance frame-by-frame by pressing »||«.
- 6 Press »▶« to resume playback.

#### Notes:

Press »DISPL« twice to open the playback menu. The »Mode« menu item allows you to select repeat functions.

In PBC, you can switch the PBC function on and off.

- 7 To stop playback,  
press »■« once if the PBC is ON,  
press »■« twice if the PBC is OFF.

# DISC PLAYBACK

---

## Frame search

- 1 Select the playback speed during playback by pressing »◀◀◀◀ or »▶▶▶▶.
- 2 Press »▶◀◀ to resume normal playback.

## Switching PBC (playback control) on and off

- 1 During playback, press »DISPL◀ or »OK◀ twice.
- 2 Select »PBC◀ with »▼◀ or »▲◀ and press »OK◀ to confirm.
- 3 Activate the PBC function with »▼◀ or »▲◀ (On) and confirm with »OK◀.

### Note:

To deactivate the PBC function, repeat the setting, but at step **3**, select »Off◀.

# DISC PLAYBACK

## Playing audio and video files



### DivX®Video CD features

DivX®Video is an encoder/decoder based on the MPEG-4 compression system which is used to encrypt and display compressed video data.

This enables the HDD DVD player to play back videos compressed in the DivX® format. This results in playback quality with fewer artefacts and higher compression.

DivX®Video files have, for example, the suffix AVI. DivX®Video data is packaged in the AVI file along with audio data compressed in MP3 format. This means:

DivX®Video and MP3 audio form the AVI file.

Further information on DivX®Video and how to create AVI files can be found under [www.divx.com](http://www.divx.com).

You can see the registration code in the »VIDEO« → »DIVX registration« menu on page 100.

### MP3 CD features

MP3 stands for MPEG-1 Audio Layer 3 and comes from the Motion Picture Expert Group (MPEG) standard, which was developed for compressing film data.

The MP3 format enables audio files to be saved on a computer with a sound quality similar to that of a CD. This only requires about 10 % of the original data quantity. The standard encoding bit rate for MP3 files is 128 kbps. Generally, the higher the bit rate of an MP3 file, the better the sound quality.

Most MP3 files on the Internet are encoded at 128 or 160 kbps. 160 kbps is considered CD quality.

MP3 files can be downloaded from the Internet and then burned onto a CD-ROM. Your HDD DVD recorder can read the ID3 tag from the file header, which contains information on the song and the artist, and displays this in the info menu/status display.

MP3 CDs contain sound recordings. They can be played in the normal manner on an audio system. The digital signals transmitted during MP3 playback are PCM encoded, regardless of the audio output setting. The signals are output with the same data rate as the music source (possibilities are: 32 kbps – 320 kbps, usually: 128 kbps).

MP3 files can be organised into folders and subfolders similar to files on a computer.



# DISC PLAYBACK

## Note:

You cannot playback from the DivX® video disc whilst recording on the HDD archive.

End the recording to play the DivX® video disc.

## Playback

- 1 Open the »MAIN MENU« of the HDD DVD recorder by pressing »i«.
- 2 Select the »▶ DVD« menu item with »▼« or »▲« and press »OK« to confirm.
  - Disc mode is selected.
  - The file browser (table of contents) of the CD is displayed.
- 3 Select the folder or title with »▲« or »▼«.
- 4 Press »OK« to open the folder.
  - A list of sub-directories appears.

## Note:

Press »◀« to go back one level.

- 5 Start playback of the title with »OK«.
  - The number of the title and the playing time appears in the display on the HDD DVD recorder.

## Note:

Press »DISPL« twice to open the playback menu. Under »Mode« you can select repeat functions.

- 6 Press »||« to pause playback.
- 7 Press »▶« to resume playback.
- 8 Press »■« to end playback.

## Viewing title information

Information about the DivX®Video title you have selected can be viewed by pressing »DISPL«.

You can view the contents of the DivX®Video CD (file browser) by pressing »■«.

Information about the MP3 title you have selected can be viewed by pressing »DISPL«.

You can view the contents of the MP3 CD (file browser) by pressing »DISPL«.

## Selecting certain titles

- 1 You can view the titles during playback by pressing »→•«.
- 2 Enter the title by pressing »1...0« and press »OK« to confirm.
  - The HDD DVD recorder locates the title and starts playback.

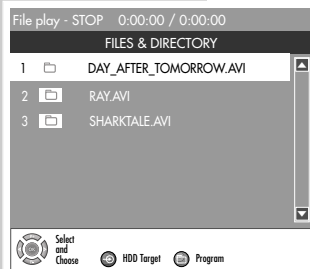

# DISC PLAYBACK

---

## Selecting a title in steps (SKIP)

- 1 Select the next title by pressing »▶|« during playback.
- 2 Press »|◀« to select the previous title.  
– Playback begins with the selected title.

## Selecting a section to the minute

- 1 During playback, enter the playing time in »1...0« five digits (hours, minutes and seconds) and press »OK« to confirm.  
– The HDD DVD recorder locates the section and starts playback.

## Frame search (DivX®Video CD only)

Several different speeds are available.

- 1 Select the playback speed during playback by pressing »◀◀◀« or »▶▶▶«.
- 2 Press »▶▶◀« to resume normal playback.

## Switching to the dubbed language or sound format (DivX®Video CD only)

A DivX®Video CD can contain various dubbed languages or audio formats.

- 1 Press »↻« during playback.
- 2 Select the »Language« line with »▼◀« or »▲◀« and press »▶▶◀« to confirm.
- 3 Select the dubbing language or the audio format with »▼◀« or »▲◀« and press »OK« to confirm.

## Selecting and showing subtitles (DivX®Video CD only)

DivX®Video CDs provide two types of subtitles.

There are the familiar subtitles available on a conventional DVD, and also subtitles shown as a separate file in the browser.

1 Press »  « during playback.

or

2 Select the subtitles file in the file browser (the file name has an extension, such as .TXT), then press »**OK**«.

– Display: »External subtitle selected« briefly appears.

In the file browser, select the DivX®Video file and press »**OK**« to start playback.

– The subtitles are displayed.



## Picture data CD playback

### JPEG CD features

JPEG stands for Joint Picture Experts Group. This process was designed to compress picture files.

JPEG files can be burned onto a CD along with other file types. These CDs are known as file CDs or mixed-mode CDs. For example, the CD could contain MP3 files (audio) and JPEG files (for example to display album covers).

The files on a JPEG CD can be organised in directories. This structure is similar to that of an MP3 CD.

JPEG CDs only contain data in the compressed JPEG format. This is mostly data from digital cameras or from imaging programs.

### Displaying pictures on a JPEG-CD

- 1 Open the »MAIN MENU« of the HDD DVD recorder by pressing »i«.
- 2 Select the »▶ DVD« menu item with »▼« or »▲« and press »OK« to confirm.
  - Disc mode is selected.
  - The file browser (table of contents) of the JPEG CD is displayed.
- 3 Press »▲« or »▼« to select the folder (or pictures).
  - A list of sub-directories appears.
- 4 Press »OK« to open the folder.

#### Note:

Press »« to go back one level.

- 5 Press »▲« or »▼« to select the picture you want to see and then »OK« to start playback.
  - Playback appears on the screen and the slide show begins.

#### Notes:

To view the picture for longer, press »||«. Press »▶« to resume playback.

Press »DISPL« once to display the file browser (table of contents) of the JPEG CD.

Press »DISPL« twice to open the playback menu. You can select repeats and other additional functions in this menu.

- 6 Press »■« to end playback.

## Random playback

- 1 Press »RND« during playback.  
– All the pictures on the JPEG CD are shown in a random order.
- 2 Press »RND« to quit the function.

## Selecting slide transition style

- 1 During playback, press »« repeatedly.  
– The type of slide transition style is displayed.



## Adjusting the picture display

The pictures can be rotated or reversed.

- 1 During playback, press »◀« or »▶« to rotate the pictures by 90°.
- 2 During playback, press »▲« or »▼« to reverse (180°) the pictures.
- 3 Press »■« to end playback.

## Enlarging the picture (zoom)

This function allows you to enlarge or reduce pictures and move them on the screen.

- 1 Press »« during playback or during a pause.
- 2 To enlarge or reduce the size of a picture section, press »« repeatedly.  
– The zoom factor is displayed.
- 3 Press »◀«, »▶«, »▲« or »▼« to move the picture section on the screen.

### Note:

You cannot move pictures which have been reduced in size.

- 4 Press »« to switch back to full picture.

# DISC PLAYBACK



## KODAK picture CD features

This method was developed for archiving analogue photographs. After they are developed, small photographs are scanned with a resolution of 1536 x 1024 pixels and burnt onto a CD in JPEG format. A KODAK picture CD can contain up to 40 pictures. In addition to the picture files, a KODAK picture CD can also contain imaging software which enables the user to play the CD on a PC, edit the pictures or view a slide show.

## Playing back a KODAK picture CD

- 1 Open the »MAIN MENU« of the HDD DVD recorder by pressing »i«.
- 2 Select the »► DVD« menu item with »▼« or »▲« and press »OK« to confirm.  
– Disc mode is selected.
- 3 When you select disc mode, playback starts automatically. The slide show proceeds automatically.  
If playback is not started automatically, start by pressing »►«.
- 4 To view the picture for longer, press »||«.  
Press »►« to continue picture playback.

## Adjusting the picture display

The pictures can be rotated or reversed.

- 1 During playback, press »◀« or »▶« to rotate the pictures by 90°.
- 2 During playback, press »▲« or »▼« to reverse the pictures.
- 3 Press »■« to end playback.

## Enlarging the picture (zoom)

This function allows you to enlarge or reduce pictures and move them on the screen.

- 1 Press »[Q]« during playback or during a pause.
- 2 To enlarge or reduce the size of a picture section, press »[Q]« repeatedly.  
– The zoom factor is displayed.
- 3 Press »◀«, »▶«, »▲« or »▼« to move the picture section on the screen.

### Note:

You cannot move pictures which have been reduced in size.

- 4 Press »[Q]« to switch back to full picture.

# DISC PLAYBACK

---



## Audio CD playback

### Audio CD features

You can recognise audio CDs by this logo.

Audio CDs only contain sound recordings. They can be played in the normal manner via an audio system, just as on a CD player.

The individual tracks are stored in a sequence. There are no folders.

### Playback

- 1 Open the »MAIN MENU« of the HDD DVD recorder by pressing »i«.
- 2 Select the »▶ DVD« menu item with »▼« or »▲« and press »OK« to confirm.
  - Disc mode is selected.
- 3 When you select disc mode, playback starts automatically.  
If playback is not started automatically, start it by pressing »▶«.
  - Display: Track playing time and total playing time.
  - Playback stops at the end of the CD.
- 4 Press »||« to pause playback.
- 5 Press »▶« to resume playback.

#### Note:

Press »DISPL« to open the playback menu. The »Mode« menu item allows you to select repeat functions.

- 6 Press »■« to end playback.

### Selecting tracks directly with the numerical buttons

- 1 During playback, press »1...0« to enter the one- or two-digit track number and press »OK« to confirm.
  - Playback begins with the selected track.

### Selecting a track in steps (SKIP)

- 1 Select the next track by pressing »▶|« during playback.
- 2 Press »|◀« to select the previous track.
  - Playback begins with the selected track.

### Fast search

Various speeds are available.

- 1 To select the playback speed, press »◀◀« during playback or »▶▶« repeatedly.
- 2 Press »▶« to resume normal playback.

# HDD ARCHIVE PLAYBACK

## Preparation

- 1 Switch on the television and select the preset channel for the HDD DVD recorder.
- 2 If an audio system or an AV receiver is connected to the HDD DVD recorder, switch it on and select the audio input for the HDD DVD recorder.
- 3 Press **»⏻«** to switch on the HDD DVD recorder from standby mode.
  - The television station of the first preset channel is displayed and the current programme is buffered in the time shift memory.

## Playback

- 1 Open the **»MAIN MENU«** of the HDD DVD recorder by pressing **»i«**.
- 2 Select the **»HDD«** menu item with **»▼«** or **»▲«** and confirm with **»OK«**.

or

open the HDD archive by pressing **»☐«** (yellow).

– The HDD archive is displayed and the first eight recordings are displayed.

- 3 Select the programme you want by pressing **»▼«** or **»▲«**.
  - The thumbnail index and the length of the selected recording are displayed in the contents table.
  - The symbols mean:
    - »🔒«** Title is blocked. You can only play back the title by entering a password.
    - »🔒«** Title is protected. This title cannot be edited.

- 4 Press **»▶«** to start playback.
- 5 Press **»⏸«** to pause playback (freeze-frame).
- 6 Advance frame-by-frame by pressing **»⏪«**.
- 7 Press **»▶«** to resume playback.

### Note:

Playback stops automatically at the end of the programme. Afterwards the contents table of the HDD archive is displayed.

- 8 Press **»■«** to end playback.

### Note:

The HDD DVD recorder “remembers” the last playing position. When starting playback of the title again, a message appears to ask you if you would like to play the title from the last playing position (**»Yes«**) or from the beginning of the title (**»No«**). This function is only possible if you have not marked any scenes (see page 47).



# HDD ARCHIVE PLAYBACK



## Displaying the info line

- 1 Press »DISPL« or »OK« once or twice to display the info line.
  - You will see information about the title, total running time and playback time elapsed.
  - The info line automatically disappears after a short time.

## Frame search

- 1 Select the playback speed during playback by pressing »◀◀« or »▶▶«.
- 2 Press »▶« to resume normal playback.

## Selecting chapters (SKIP)

- 1 Select the next chapter by pressing »▶|« during playback.
- 2 Select the previous chapter by pressing »|◀« during playback.
  - Playback begins with the selected chapter.

### Note:

You can set the duration of each chapter in the setup menu.

## Enlarging the picture (zoom)

This function allows you to enlarge various picture sections.

- 1 During playback, press »[Q]«.
  - Display: for example »[Q] 1.5«, the HDD DVD player enlarges a picture section.
- 2 Move the picture section around the screen with »◀«, »▶«, »▲« or »▼«.
- 3 Press »[Q]« to return to normal picture size.

## Repeating a track

- 1 Press »[R]« during playback.
  - Display: »[R]«, the current track being played will be repeated.
- 2 To quit the function, press »[R]« again.





# HDD ARCHIVE PLAYBACK

## Selecting and playing scenes

You can make a bookmark for a scene of a recording in the HDD archive. This bookmark can be selected directly for playback. You can set one bookmark per recording.

### Setting bookmarks

- 1 Press »  « during playback.  
– Display: »  «.

#### Note:

This bookmark is automatically overwritten if you create a new one.

### Playing bookmarked scenes

- 1 During playback, press and hold down »  «.  
– Playback starts at the point marked.

### Deleting bookmarks

- 1 Press » **CL** « during playback.



# DISC PLAYBACK – CONVENIENCE FUNCTIONS

The sound is muted for the picture search, slow motion and freeze-frame functions.

Depending on the disc in use, some of these functions may be unavailable.

## Selecting titles and chapters

If a disc has multiple titles or chapters you can select them separately.

### Selecting titles and chapters step by step

- 1 During playback, select the title or chapter by pressing »►|◀ or »|◀◀.

### Selecting titles and chapters directly

- 1 During playback, press »→●◀ to open the input option (title or chapter) you want.
- 2 Enter the title or chapter using »1...0◀ and press »OK◀ to confirm.  
– Playback starts with the selected title or chapter.

### Selecting a section to the nearest minute

- 1 During playback, press »→●◀ several times to open the time display.
- 2 Enter the playing time in five digits (hours, minutes and seconds) using »1...0◀ and press »OK◀ to confirm.  
– The HDD DVD recorder locates the section and starts playback.

## Selecting functions in the playback menu

- 1 During playback, press »DISPL◀ or »OK◀ twice.  
– The playback menu appears.
- 2 Select the item by pressing »▲◀ or »▼◀ and activate it with »►◀.
- 3 Select the function you want by pressing »▲◀ or »▼◀ and press »OK◀ to confirm.
- 4 Switch off the repeat menu with »◀◀ or »DISPL◀.

## Pausing and resuming playback

You can pause the playback of a DVD at any point and then resume from the same place.

- 1 To pause playback, press »■◀ once.
- 2 Press »►◀ to resume playback at the point where it was pause.



# DISC PLAYBACK – CONVENIENCE FUNCTIONS

## Frame search

You can choose amongst various speeds (forwards or backwards).

- 1 Select the forward or reverse playback speed during playback by repeatedly pressing »◀◀◀ or »▶▶▶◀.
- 2 Press »▶▶◀ to resume normal playback.

## Slow motion

Different (forward) playback speeds are available.

- 1 Press »▶▶▶◀ during playback.
- 2 Press »▶▶▶◀ to select the slow motion speed.
- 3 Press »▶▶◀ to resume normal playback.

## Frame-by-frame playback

- 1 Press »▶▶▶▶◀ during playback.
- 2 Advance frame-by-frame by pressing »▶▶▶▶◀.
- 3 Press »▶▶◀ to resume normal playback.

## Selecting camera angles for scenes\*

Some DVDs contain scenes or passages which were filmed several times from different camera locations (camera angles).

You can choose amongst these different angles.

- 1 Press »▶▶▶▶◀ during playback to select the camera angle function.  
– Display: Angle »2/4◀, in this example 2 of 4.
- 2 Press »▶▶▶▶◀ to select a different camera angle.

## Enlarging and moving the screen section (zoom)



- 1 Press »▶▶▶▶◀ during playback or pause.
- 2 Press »▶▶▶▶◀ to select the zoom factor.  
– The HDD DVD recorder enlarges a screen section.
- 3 Move the picture section around the screen with »▶◀◀, »▶▶▶◀, »▶▶▶▶◀ or »▶▶▶▶▶◀.
- 4 Press »▶▶▶▶◀ to return to normal playback.

\* Depends on the disc in use.

# DISC PLAYBACK – CONVENIENCE FUNCTIONS

## Switching the dubbed language or the audio format\*

These settings allow you to listen to a dubbed language other than the default one if the DVD provides alternatives.



- 1 Press »   « during playback.  
– Display: for example »AUDIO: 02/03 GER«.
- 2 Press »  « to select the audio language you want.

### Note:

The structure of the DVD itself may stop you from switching the audio language. In this case you can usually make the setting in the DVD menu.

## Selecting and displaying subtitles\*

If the DVD provides subtitles, they can be displayed on your TV screen. If subtitles are available in several languages, you can select the ones you want.

- 1 Press »  « during playback.  
– Display: for example »SUBTITLE: 02/10 GER«.
- 2 Press »  « to select the subtitle language.





### Notes:

To switch off the subtitles, keep pressing »  « until »Off« appears in the display.

The structure of the DVD itself may stop you from activating and deactivating subtitles. In this case you can usually make the setting in the DVD menu.

## Creating and playing a playlist

You can compile titles or chapters into a playlist. The titles in the »Playlist« are played back in sequence.

- 1 Press »**PROG**« during playback.
- 2 In the »TITLE« (or »Files and folders« list – depending on the disc in use), select the title, chapter or picture with »  « or »  « and press »**CL**« to add it to the »Playlist«.
- 3 Press »  « to select »Playlist« and »  « to start playback.

### Notes:

Individual titles in the »Playlist« can be deleted with »**CL**«. The whole list is deleted if you switch off the HDD DVD recorder or take out the disc. You can hide the »Program play list« by pressing »  «.

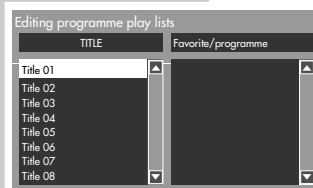

# DISC PLAYBACK – CONVENIENCE FUNCTIONS

## Repeating a chapter, a title or a disc

Depending on the type of disc, you can repeat chapters, titles, folders or the entire disc.

- 1 To repeat the chapter, press »↔« during playback until »Repeat chapter« appears in the display.  
– The chapter currently playing is repeated.

or

To repeat the title, press »↔« during playback until »Repeat title« appears in the display.  
– The current title is repeated.

or

To repeat the entire disc, press »↔« during playback until »Repeat disc« appears in the display.  
– The disc is repeated.

- 2 To quit the function, keep pressing »↔« until »Normal« appears in the display.

## Repeating a selected section (A-B Repeat)

You can mark the beginning and end of a section and play it repeatedly.

- 1 Press »A-B« during playback.  
– Display: »Set A-«, the start of the section is marked.
- 2 Press »A-B« again to mark the end of the scene.  
– Display: »Repeat A-B«, the marked section is constantly repeated.
- 3 Press »A-B« again to quit the function.  
– Display: »NORMAL«.

# RECORDING – GENERAL INFORMATION

## Recording options

You can record television programmes on the HDD archive of the HDD DVD recorder or on a DVD+RW/-RW and DVD+R/-R.

- Immediately, with one touch recording – which means you select the channel on the HDD DVD recorder and start recording straight away.
- At a later stage – by entering data for the TV channel.
- With option 2 you can program up to eight programmes up to a year in advance, or record programmes at the same time every day or week.
- You can also record films from external devices such as camcorders connected to the »**DV IN**« or »**VIDEO IN**« and »**L AUDIO IN R**« sockets on the HDD DVD recorder.

## Suitable discs for recording

You can use DVD+R/-R and DVD+RW/-RW discs for recording.

DVD+R/-Rs can only be recorded on once. If you want to play these discs on a DVD player, you first have to finalise them. Once they have been finalised, they can no longer be recorded on.

If you only want to play them on your HDD DVD recorder, you do not have to finalise them.

You can add more recordings and delete them as necessary.

Note that any playing time you delete is no longer available for recording.

DVD+RW/-RWs (rewritable) can be recorded on very often (up to a thousand times) and deleted.

You may have to delete recordings made by other devices on DVD+RW/-RWs before you can record on them.

## Unsuitable discs

- Damaged discs cannot be recorded on.
- Finalised discs cannot be recorded on. This can only be done with unfinalised discs.
- Full discs cannot be recorded on.
- Very rarely, discs are defective and therefore cannot be recorded on. Try recording on another disc.

## Initialising discs

The DVD+R/+RW or DVD-R/-RW is automatically initialised before recording, this can take a few minutes.

Only then is recording possible.

# RECORDING – GENERAL INFORMATION

## Recording quality and time

### For the disc

You can set the quality of the recording. The table below shows the relationship between quality and recording time:

Quality	Time
HQ – Very high quality	60 minutes on a 4.7 GB blank DVD
SP – High quality	120 minutes on a 4.7 GB blank DVD
SP+ – Good quality	150 minutes on a 4.7 GB blank DVD
LP – S-VHS picture quality	180 minutes on a 4.7 GB blank DVD
EP – Better than VHS picture quality	240 minutes on a 4.7 GB blank DVD
SLP – VHS picture quality	360 minutes on a 4.7 GB blank DVD
SEP – Longest recording time	480 minutes on a 4.7 GB blank DVD

### For the HDD archive

You can set the quality of the recording. The table below shows the relationship between quality and recording time:

Quality	Time
HQ – very high recording quality	35 hours
SP – high recording quality	67 hours
SP+ – good recording quality	83 hours
LP – S-VHS picture quality	101 hours
EP – better than VHS picture quality	133 hours
SLP – VHS picture quality	203 Stunden
SEP – longest recording time	272 hours

#### Notes:

The quality and recording time are interdependent. The better the quality, the more memory the recording requires. This means that the recording time is shorter in high quality mode than in standard quality mode.

The recording quality (HQ, SP, SP+, LP, EP, SLP or SEP) is selected automatically during playback.

Playback is viewed with the recording quality that was selected for the recording.

# RECORDING – GENERAL INFORMATION

## Note on recording quality

Pay attention to the recording quality, whether you set it manually or with the timer, when you want to record a program in the HDD archive and then transfer it to a disc at a later point.

If you select a very high recording quality, a 90 minute film might not fit onto the disc. To record the film you will have to divide the film into two parts.

You cannot subsequently reduce the quality of the recording.

## Remaining recording time

You can find information about the remaining recording time in the »EMPTY« field in the index screen.

- 1 Press »►◀« to select the index screen.
- 2 Select the »EMPTY« field with »▼◀« and activate by pressing »►▶«.
- 3 Select »Properties« with »▼◀« and press »OK◀« to confirm.  
– The recording time still available – depending on recording quality – is displayed.

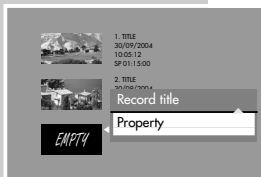

## Recording settings

You can make settings, such as adding chapter markers, selecting the input source and setting the recording quality, in the setup menu. The settings are described on page 96.

## Data management in the HDD archive







If you want to record programs manually in the HDD archive that are longer than three hours, they will be displayed in the HDD archive separately.

As an example, you record something for 4:30 hours. In the HDD archive the first entry with 02:59 hours will be displayed and then the second entry with 01:31 hours.

If you want to avoid this, record the program(s) in timer mode.

# RECORDING ON DISC

## Preparing for recording







- 1 Switch on the television and select the preset channel for the HDD DVD recorder.
- 2 Press »« to switch on the HDD DVD recorder from standby mode.
- 3 Briefly press »« on the HDD DVD recorder or press and hold down »« on the remote control.  
– Display: »«, the disc compartment opens.
- 4 Put a disc in the disc compartment with the label facing upwards.
- 5 Press »« on the HDD DVD recorder or press and hold down »« on the remote control.

### Recording from a satellite receiver:

If the television programme is being recorded from a satellite receiver, switch on the satellite receiver and select the satellite channel you want.

Select the channel position »EURO-AV 2« for the satellite receiver on the HDD DVD recorder with »**SOURCE**« or »**0**« (AV).

## Manually recording television programmes

- 1 When you switch on the HDD DVD recorder, the current programme that you can see on the television screen is recorded in the time shift memory.
- 2 Switch to disc mode by pressing »« (blue).  
– A message is displayed to quit timeshift mode by pressing »**OK**«.  
– Afterwards the disc type, the selected recording quality, the current and remaining playing time available (depending on the recording quality) are displayed.
- 3 Press »**SOURCE**« to select the input source (for example, TV).  
– Display: for example, »P1 BBC«, the current TV station is shown.
- 4 Press »« or »« or use the numerical buttons »**1...0**« to select the TV channel or open the programme list with »**OK**«, press »« or »« to select the TV channel and switch off the programme list with »«.

### Note:

If you want to change the preset recording quality, press »**Q-SET**« until the quality you want appears in the display.

Sys status: STOP  
Record To Optical Disc as (75min/GB)  
Elapsed Time: 00:00:00 Remain Space: 02:05:00



# RECORDING ON DISC

Sys state: RECORDING  
Record To Optical Disc as (25min/CB)  
Elapsed Time: 00:00:10 Remain Space: 02:04:50

Select and Choose  
HDD Exit

- 5 Press **»●«** to start recording.  
– The amount of recording time available is shown.

## Notes:

During the recording, you can press **»●«** to enter the switch-off time (30 minutes, 60 minutes, 90 minutes, none).

The switch-off time depends on the playing time left on the disc.

The HDD DVD recorder automatically switches off the recording after this time.

The info line can be hidden by pressing **◀▶**.

- 6 Press **»||«** to pause recording.
- 7 Press **»●«** to resume recording.
- 8 Press **»■«** to end the recording.  
– A warning message appears.  
Press **»OK«** to acknowledge it.  
– The HDD DVD recorder updates the contents table of the disc.

## Note:

If this message is not acknowledged, the HDD DVD recorder continues the recording.

- 9 After a short while the **»YesDVD«** menu appears (only DVD+R/+RW).

## Notes:

If you wish to use the YesDVD function, please read the section on executing the YesVideo function on the next page.

If you do not wish to use the YesDVD function, select **»No«** with **»▼«** in the menu and confirm it with **»OK«**.

The YesDVD function cannot be used with recorded discs. This disc must be deleted before recording.

## Finalising a disc (DVD+R/-R/-RW)

If you want to play programmes recorded on your HDD DVD recorder on a DVD player, you must first finalise the disc as described in the section on finalising discs (DVD+R/-R/-RW) on page 76.

## Note:

Once the disc has been finalized, no further recording is possible.

## Error messages

The HDD DVD recorder displays messages showing how to deal with any errors which might occur.



# YES DVD FUNCTION

The YesDVD function allows you to make professional home videos from your recordings.

At the end of recording, the HDD DVD recorder automatically creates a chapter overview, which is displayed as thumbnail images in the disc menu.

At the same time, a music video is created using three scenes from the recording.

You can put the finished disc into a computer, make a cover for the sleeve and print it out.

The YesDVD function can only be used with DVD+Rs and DVD+RWs. There may not be any recordings on the DVD+Rs and DVD+RWs.

The discs are finalised with the YesDVD function and cannot be used for further recordings. However, DVD+RWs can be deleted again.

## Activating and deactivating the YesDVD function

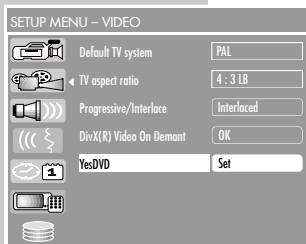

- 1 Press »SET UP« to open the setup menu.
- 2 Select »SETUP-MENU – VIDEO« (  ) with »▼« or »▲« and press »OK« to confirm.
- 3 Select »YesDVD« with »▼« or »▲« and activate with »OK«.
- 4 Select »YesDVD« or »Music Video« with »▼« or »▲« and activate with »OK«.
- 5 Activate the function by pressing »▼« or »▲« (»ON«) and press »OK« to confirm.
- 6 Press »SET UP« to exit the menu.

## Executing the YesDVD function

- 1 Activate the YesDVD function in the setup menu.
- 2 Make the recording on the disc.
- 3 At the end of the recording a menu is displayed, requesting you to activate the YesDVD function.
- 4 Confirm the YesDVD function with »OK«.  
– The YesDVD disc is created. This can take some time, for example, fifteen minutes for a two hour recording.
- 5 Acknowledge the message »The YesDVD has been ...« by pressing »OK«, remove the disc from the HDD DVD recorder and insert it into the disc compartment of a computer.
- 6 Open the "Index" document and follow the instructions of the program.
- 7 Print the cover for the disc.

# RECORDING ON THE HDD ARCHIVE

## Preparing for recording

- 1 Switch on the television and select the preset channel for the HDD DVD recorder.
- 2 Switch the HDD DVD recorder to and from standby with »**⏻**« on the remote contro.

### Note:

Please select the recording quality before starting the recording. See the section on custom settings and selecting the recording quality on page 96.

### Recording from a satellite receiver:

If the television programme is being recorded from a satellite receiver, switch on the satellite receiver and select the satellite channel you want.

Select the channel position for the satellite receiver with »**SOURCE**« or »**0**« (AV).

## Manually recording television programmes



- 1 When you switch on the HDD DVD recorder, the current programme that you can see on the television screen is recorded in the time shift memory.
- 2 Press »**SOURCE**« to select the input source (for example, TV).  
– Display: for example, »P1 ARD«, the current TV station is shown.
- 3 Press »**▲**« or »**▼**« or use the numerical buttons »**1...0**« to select the TV channel or open the programme list with »**OK**«, press »**▲**« or »**▼**« to select the TV channel and switch off the programme list with »**⏪**«.
- 4 Press »**●**« to start recording.  
– The amount of recording time available is shown.



### Notes:

During the recording, you can press »**●**« to enter the switch-off time (30 to 690 minutes in 30-minute increments). The HDD DVD recorder automatically switches off the recording after this time. Press »**CL**« to stop the recording, the data will not be saved.

- 5 Press »**||**« to pause.
- 6 Press »**▶**« to resume recording.  
– Note that this is no longer a "LIVE" recording.
- 7 Press »**■**« to end the recording.  
– A message appears. Press »**OK**« to acknowledge.  
– You can see the data for the recording in the HDD archive.

### Note:

If this message is not acknowledged, the HDD DVD recorder continues the recording.

# SIMULTANEOUS OPERATING MODES

## Recording on the HDD archive and simultaneous playback from the HDD archive

- 1 Switch on the television and select the preset channel for the HDD DVD recorder.
- 2 Press **»⏻«** to switch on the HDD DVD recorder from standby mode.
  - When you switch on the HDD DVD recorder, the current programme that you can see on the television screen is recorded in the time shift memory.

### Note:

Please select the recording quality before starting the recording. See the section on custom settings and selecting the recording quality on page 96.

- 3 Press **»SOURCE«** to select the input source (for example, TV).
  - Display: for example, **»P1 ARD«**, the current TV station is shown.
- 4 Press **»▲«** or **»▼«** or use the numerical buttons **»1...0«** to select the TV channel or open the programme list with **»OK«**, press **»▲«** or **»▼«** to select the TV channel and switch off the programme list with **»↩«**.
- 5 Press **»●«** to start recording.

### Note:

The recording is continued in the background.

- 6 Open the HDD archive by pressing **»☐«** (yellow).
- 7 Select the title by pressing **»▼«** or **»▲«**.
  - The thumbnail index of the selected recording is displayed in the contents table.
- 8 Press **»▶«** to start HDD archive playback.
- 9 Press **»■«** to end HDD archive playback.
  - The contents table of the HDD archive is displayed.
- 10 Switch to recording mode with **»⊕«** (blue) and end the recording with **»■«**.
  - A message appears. Press **»OK«** to acknowledge.
  - You can see the data for the recording in the HDD archive.

### Note:

If this message is not acknowledged, the HDD DVD recorder continues recording.



# SIMULTANEOUS OPERATING MODES







## Recording on the HDD archive and simultaneous playback from disc

- 1 Switch on the television and select the preset channel for the HDD DVD recorder.
- 2 Press »« to switch on the HDD DVD recorder from standby mode.
  - When you switch on the HDD DVD recorder, the current programme that you can see on the television screen is recorded in the time shift memory.







### Note:

Please select the recording quality before starting the recording. See the section on custom settings and selecting the recording quality on page 96.







- 3 Press »**SOURCE**« to select the input source (for example, TV).
    - Display: for example, »P1 ARD«, the current TV station is shown.
  - 4 Press »« or »« or use the numerical buttons »1...0« to select the TV channel or open the programme list with »**OK**«, press »« or »« to select the TV channel and switch off the programme list with »«.
- 5 Start recording on the HDD archive with »«.

### Note:

The recording is continued in the background.

- 6 Press »« on the HDD DVD recorder or press and hold down »« on the remote control.
  - Put the disc in the disc compartment, with the label facing upwards.
  - Press »« on the HDD DVD recorder or press and hold down »« on the remote control.
- 7 Press »« to switch to disc mode.
  - The index screen is displayed.



- 8 Select the title by pressing »« or »«.
- 9 Press »« to start playback of the disc.
- 10 Press »« to end playback of the disc.
- 11 Switch to recording mode with »« (blue).
- 12 End recording on the HDD archive with »«.
  - A message appears. Press »**OK**« to acknowledge.
  - You can see the data for the recording in the HDD archive.

### Note:

If this message is not acknowledged, the HDD DVD recorder continues recording.

# SIMULTANEOUS OPERATING MODES

## Recording on disc and simultaneous playback from the HDD archive

- 1 Switch on the television and select the preset channel for the HDD DVD recorder.
- 2 Press **»⏻«** to switch on the HDD DVD recorder from standby mode.
  - When you switch on the HDD DVD recorder, the current programme that you can see on the television screen is recorded in the time shift memory.

### Note:

Please select the recording quality before starting the recording. See the section on custom settings and selecting the recording quality on page 96.

- 3 Switch to disc mode with **»⏻«** (blue).
  - A message appears. Press **»OK«** to acknowledge.
- 4 Open the disc compartment, insert the disc with the label facing upwards and close it.
  - Display: The recording time and the amount of recording time still available.
- 5 Press **»SOURCE«** to select the input source (for example, TV).
- 6 Press **»▲«** or **»▼«** or use the numerical buttons **»1...0«** to select the TV channel or open the programme list with **»OK«**, press **»▲«** or **»▼«** to select the TV channel and switch off the programme list with **»⏪«**.
- 7 If you would like to change the recording quality, press **»Q-SET«** until the recording quality you want appears in the display.
- 8 Press **»●«** to start recording on the disc.
  - The amount of recording time available is shown.
- 9 Open the HDD archive by pressing **»□«** (yellow).
- 10 Select the title by pressing **»▼«** or **»▲«**.
  - The thumbnail index of the selected recording is displayed in the contents table.
- 11 Press **»▶«** to start HDD archive playback.
- 12 Press **»■«** to end HDD archive playback.
- 13 Press **»⏻«** (blue) to switch back to disc mode.
- 14 Press **»■«** to end recording on the disc.
  - A message appears. Press **»OK«** to acknowledge.
  - You can see the recording data in the table of contents on the disc.

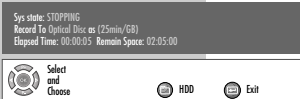
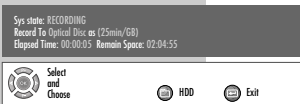

# COPYING

If the HDD archive is full up or you want to make a back-up copy of special recordings, you can copy the data from the HDD archive onto a disc.

- 1 To make a copy, put a DVD+R, DVD+RW, DVD-R or DVD-RW into the disc compartment.
- 2 Press »i« to open the main menu.
- 3 Select »HDD« with »▼« or »▲« and activate with »OK«.  
– The HDD archive is displayed.

## Note:

You can also open the HDD archive by pressing »□« (yellow).

- 4 Press »▼« or »▲« to select the title.
- 5 Mark the title by pressing »□«.  
– A status line is displayed above the index screen. This line shows the space required by the title on the disc as a graph and in percent.
- 6 Start copying the title with »●«.  
– The »●« symbol is displayed during the copying process.

## Notes:

You can mark and skip over several titles.

If the length of the title is greater than the space left on the disc, the message »DVD is full« appears. To copy the title you must split it, see the section on splitting titles in two on page 79.



# TIMER RECORDING

## Programming recordings by entering the data for the television programme

### Notes:

You can store the television programme on a disc or in the HDD archive.

The time and date on the HDD DVD recorder must be accurate. If all the timer positions are occupied and you want to program a new recording you must delete one, as described in the section on deleting recording data on page 66.

### Preparation

Switch on the television.

Select the »AV« channel on the television for the HDD DVD recorder.

Insert a DVD+R, DVD+RW, DVD-R or DVD-RW in the disc compartment.

When you switch on the HDD DVD recorder, the current programme that you can see on the television screen is recorded in the time shift memory.

### Example

- 1 Press »i« to open the main menu.
- 2 Select »Timer list« by pressing »▼« or »▲« and activate with »OK«.  
– The »Timer list« is displayed.

### Note:

You can also open the »Timer list« by pressing »⏻« (green).

- 3 Activate the »Item editor« with »OK«.  
– The »Item editor« menu appears.
- 4 Select »Source« with »▼« or »▲« and press »OK« to confirm.  
Select the TV channel with »▼« or »▲« and press »OK« to confirm.

### Note:

If you want to record the video and audio signal from an external device instead of the TV channel, select »Front CVBS«, »Rear CVBS«, »Rear S-VIDEO«, »EURO-AV«, »EURO-AV 2« or »EURO-AV 2 SV« as the input source by pressing »▼« or »▲«.

### Recording from a satellite receiver:

If you want to record programmes from a connected satellite receiver, press »▼« or »▲« to select the »EURO-AV 2« channel, and select the TV station on the satellite receiver. The satellite receiver must be switched on at the selected recording time and for the duration of the timer recording.

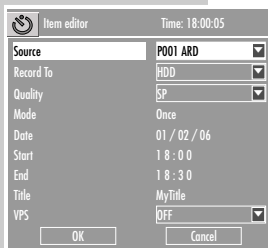

# TIMER RECORDING

Item editor Time: 18:00:05

Source: P001 ARD

Record To: HDD

Quality: SP

Mode: Once

Date: 01 / 02 / 06

Start: 18 : 0 0

End: 18 : 3 0

Title: MyTitle

VPS: OFF

OK Cancel

5 Select »Record To« with »▼« or »▲« and activate with »OK«.

Select the recording medium (HDD = HDD archive, DVD = disc) with »▼« or »▲« and confirm with »OK«.

6 Select »Quality« with »▼« or »▲« and press »OK« to confirm.

Select the recording quality with »▼« or »▲« and press »OK« to confirm.

7 Select »Mode« with »▼« or »▲« and press »OK« to confirm.

– »Once«, the recording is made once.

– »Daily«, the recording is made at the same time every day from Monday to Sunday.

– »Weekly«, the recording is made at the same time on the same day every week.

– »Mon - Fri«, the recording is made at the same time every day from Monday to Friday.

– »Mon - Sat«, the recording is made at the same time every day from Monday to Saturday.

– »Weekend«, the recording is made at the same time every weekend.

Select the recording mode with »▼« or »▲« and press »OK« to confirm.

Item editor Time: 18:00:05

Source: P001 ARD

Record To: HDD

Quality: SP

Mode: Once

Date: 01 / 02 / 06

Start: 18 : 0 0

End: 18 : 3 0

Title: MyTitle

VPS: OFF

OK Cancel

8 Select »Date« with »▼« or »▲« and press »OK« to confirm. Enter the recording date in six-digits with »1...0« and confirm with »OK«.

9 Select »Start« with »▼« or »▲« and press »OK« to confirm. Enter the four-digit start time with »1...0« and press »OK« to confirm.

Item editor Time: 18:00:05

Source: P001 ARD

Record To: HDD

Quality: SP

Mode: Once

Date: 01 / 02 / 06

Start: 20:15

End: 18 : 3 0

Title: MyTitle

VPS: OFF

OK Cancel

10 Select »End« with »▼« or »▲« and press »OK« to confirm. Enter the four-digit stop time with »1...0« and press »OK« to confirm.

11 Select »Title« with »▼« or »▲« and press »OK« to confirm. Enter a name for the title (up to eight letters/characters):

Select letters/characters with »▼« or »▲«.

Switch to the next/previous letter or character with »◀« or »▶«.

Press »OK« to confirm the setting.

Item editor Time: 18:00:05

Source: P001 ARD

Record To: HDD

Quality: SP

Mode: Once

Date: 01 / 02 / 06

Start: 20:15

End: 21:45

Title: MyTitle

VPS: OFF

OK Cancel

12 Select »VPS« with »▼« or »▲« and press »OK« to confirm. Switch on VPS/PDC control »▼« or »▲« (On) – if required. (For »VPS On« the starting time must be entered to the nearest minute according to the TV guide.)



# TIMER RECORDING



- 13 Select »OK« with »▼« or »▲« and press »OK« to confirm the recording data.  
– The »Timer list« menu appears on the screen.

### Note:

If you do not want to save the timer data, select »Cancel« with »▼« or »▲« and press »OK« to confirm.

- 14 To make further recordings, repeat the instructions from step 3 or exit the »Timer list« menu with »⏻« (green).

- 15 Switch the HDD DVD recorder to standby by pressing »⏻« on the remote control.  
– Display on the HDD DVD recorder: »⏻«.

### Caution:

Remember that the HDD DVD recorder can only record after you press »⏻« on the remote control to switch it to standby.

### Note:

The timer recordings can be cancelled by pressing »■«.

## Messages during or after programming a recording

- »Recording due to start – switch off the HDD DVD recorder«  
A programmed recording is due to start shortly.  
Press »⏻« to switch off the HDD DVD recorder.
- »Timer starts in 3 minutes, press OK to start«  
A programmed recording is due to start shortly. Press the »OK« button.
- »No recording possible. No disc in the disc compartment.«  
There is no disc in the compartment, or the disc is unsuitable for recording. Put in another disc.
- »Recording due to start, please insert a disc with sufficient recording capacity«  
The disc is write-protected or there is not enough playing time left on it.  
Remove the write protection or put in another disc.
- »Input error«  
Check the recording data for the programme (date, start time and stop time) and change if necessary.
- »Input error. Clashes with another timer recording.«  
The recording times of two programmes overlap.  
Change the recording data for one of the programmes or delete it.

# TIMER RECORDING

---



## Checking, modifying or deleting recording data

### Preparation



Switch on the television.

Select the »AV« channel on the television for the HDD DVD recorder.



### Checking recording data

- 1 Open the »Timer list« menu by pressing »  « (green).  
– The »Timer list« menu appears, displaying the current data.
- 2 Press »▼« or »▲« to select the timer position.
- 3 Close the »Timer list« menu by pressing »  «.

### Editing recording data

- 1 Open the »Timer list« menu by pressing »  « (green).  
– The »Timer list« menu appears, displaying the current data.
- 2 Press »▼« or »▲« to select the timer position and activate with »OK«.  
– The »Item editor« menu appears.
- 3 Press »▼« or »▲« to select the recording data, press »OK« and then »▼« or »▲« or »1...0« to edit the data.  
Press »OK« to confirm each change.
- 4 Select »OK« with »▼« or »▲« and press »OK« to save the recording data.
- 5 Close the »Timer list« menu by pressing »  «.

### Deleting recording data

- 1 Open the »Timer list« menu by pressing »  « (green).  
– The »Timer list« menu appears, displaying the current data.
- 2 Press »▼« or »▲« to select the timer position.
- 3 Press »CL« to delete the recording data.
- 4 Close the »Timer list« menu by pressing »  «.

# EDITING DATA ON A DISC

The index screen of the DVD+R, DVD+RW, DVD-R and DVD-RW shows the title, length, quality and date of the recording. The first frame of the recording is also displayed.

If the »Automatic chapter marking« is activated, the HDD DVD recorder makes chapter markings during the recording. You can set the time intervals by referring to the chapter on "Inserting chapter markers in recordings" on page 96. You can edit, delete or add new ones later on.

You can also edit the name of the recording, rename the disc, and delete individual recordings or all recordings.

## Editing titles

### Opening the editing menu

- 1 Put a DVD+R, DVD+RW, DVD-R or DVD-RW in the disc compartment.
- 2 Press »i« to open the main menu.
- 3 Select »► DVD« by pressing »▼« or »▲« and activate with »OK«.  
– The index screen appears.
- 4 Select the title by pressing »▼« or »▲«.
- 5 Activate the DVD menu with »►«.  
– The »DVD menu« is displayed.
- 6 Select »Edit title« with »▼« or »▲« and press »OK« to confirm.  
– The »Edit mode« menu appears.

#### Notes:

The rest of the process is described in the following sections, starting from step 1.

### Adding chapter markers

You can add chapter markers within a title to allow you to find scenes quickly during playback.

You can add up to 99 markers on each disc. After the 99th marker, the HDD DVD recorder displays the message »Too many chapters«. To insert new markers, old ones must first be deleted.

You cannot add markers if the disc is write-protected or finalised.

- 1 Select »Title« with »▼« or »▲« and press »OK« to activate.
- 2 Press »1...0« to enter the title and press »OK« to confirm.

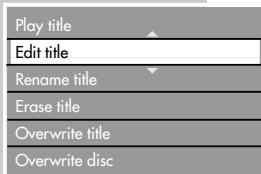

# EDITING DATA ON A DISC

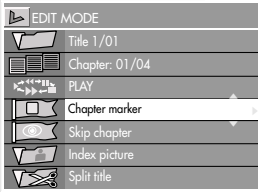

- 3 During playback, select »Chapter marker« with »▼« or »▲« and activate with »▶«.
- 4 To add your own markers, select »Insert marker« with »▼« or »▲« and press »OK« to insert the marker at the selected scene.
- 5 Quit the function by pressing »←« or »⊞«.

## Deleting chapter markers

You can delete individual chapter markers or all the chapter markers on the disc.

- 1 Select »Title« with »▼« or »▲« and press »OK« to activate.
- 2 Press »1...0« to enter the title and press »OK« to confirm.
- 3 Select »Chapter marker« with »▼« or »▲« and press »▶« to confirm.
- 4 To delete the current chapter marker, select »Delete marker« with »▼« or »▲« and press »OK« to delete it

or

To delete all the chapter markers select »Delete all markers« with »▼« or »▲« and press »OK« to delete them.

- 5 Quit the function by pressing »←« or »⊞«.

## Skipping chapters

You can mark chapters to be skipped during playback.

- 1 Select »Title« with »▼« or »▲« and press »OK« to activate.
- 2 Press »1...0« to enter the title and press »OK« to confirm.
- 3 Select »Chapter:« with »▼« or »▲« and press »1...0« to select a chapter.
- 4 Select »Skip chapter« with »▼« or »▲« and press »OK« to confirm.  
– The chapter is skipped during playback.

### Note:

If you want to see the chapter again, select it with »1...0«, select »Show chapter« with »▼« or »▲« and press »OK« to confirm.

- 5 Quit the function by pressing »←« or »⊞«.

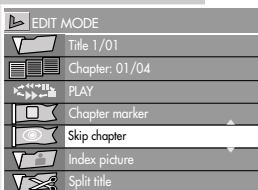
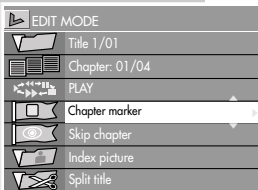

## Creating a new title thumbnail

You can select and save any scene as a new index thumbnail picture for the title.

- 1 Select »Title« with »▼« or »▲« and press »OK« to activate.
- 2 Press »1...0« to enter the title and press »OK« to confirm.
- 3 Select »Index picture« by pressing »▼« or »▲«.
- 4 Press »OK« at the scene you want to use as an index thumbnail.
- 5 Quit the function by pressing »←« or »⊞«.

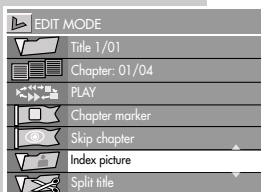

## Splitting titles in two (DVD+RW and DVD-RW only)

You can split a title into two. You can then delete these two titles separately, so that you can use the memory space on the disc again.

- 1 Select »Title« with »▼« or »▲« and press »OK« to activate.
- 2 Press »1...0« to enter the title and press »OK« to confirm.
- 3 Select »Split title« with »▼« or »▲« and press »OK« to confirm.  
– The title is split.

### Note:

Depending on the length of the title, this can take some time.

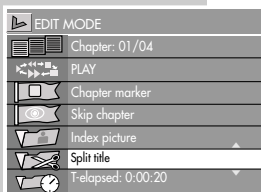

# EDITING DATA ON A DISC

## Editing the names of recordings

You can give recordings a name.

- 1 Put a DVD+R, DVD+RW, DVD-R or DVD-RW in the disc compartment.
- 2 Press »i« to open the main menu.
- 3 Select »► DVD« by pressing »▼« or »▲« and activate with »OK«.  
– The index screen appears.
- 4 Press »▼« or »▲« to select the title and activate the title menu with »►«.  
– The »Title menu« is displayed.
- 5 Select »Rename title« by pressing »▼« or »▲« and press »OK« to confirm.
- 6 Press »◀« or »▶« to select the input position and »▼« to switch to the keyboard.
- 7 Press »▼«, »▲«, »◀« or »▶« to select letters characters, and »OK« to confirm.

### Notes:

The buttons at the bottom of the keyboard are function keys:

Press »cC« to switch between uppercase and lowercase. Press »BkSp« to delete a character and »Clear« to delete a word. Press »Exit« or »◀« to quit the keyboard. Any changes are not saved.

- 8 When you have entered the new name, press »▼«, »▲«, »◀« or »▶« to switch to the »OK« button and press »OK« to confirm.  
– Display: »Updating disc... Please wait«.
- 9 Press »◀« to complete the setting.

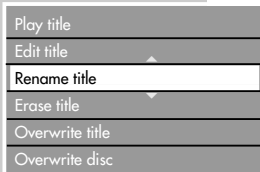

# EDITING DATA ON A DISC

## Deleting titles (recordings) from the disc

- 1 Put a DVD+R, DVD+RW, DVD-R or DVD-RW in the disc compartment.
- 2 Press »i« to open the main menu.
- 3 Select »► DVD« by pressing »▼« or »▲« and activate with »OK«.  
– The index screen appears.
- 4 Press »▼« or »▲« to select the title and activate the title menu with »►«.  
– The »Title menu« is displayed.
- 5 Select »Erase title« with »▼« or »▲« and press »OK« to confirm.  
– Display: »Warning: this operation will irreversibly delete the current title on the disc. Do you want to continue?«.
- 6 Select »Yes« with »◀« or »▶« and press »OK« to confirm.  
– Display: »Erasing ...«. The title overview now shows a blank title.

### Notes:

Deleted titles on a DVD+R/-R are only marked as deleted. The playing time of these titles cannot be used for further recordings. The title is simply skipped during playback.

Once a DVD+R/-R is finalised, deleting is no longer possible.

## Overwriting titles

This function allows you to use free recording space on the disc.

Note that only the playing time of the title to be overwritten is available for recording.

- 1 Put a DVD+RW or DVD-RW in the disc compartment.
- 2 Press »i« to open the main menu.
- 3 Select »► DVD« by pressing »▼« or »▲« and activate with »OK«.  
– The index screen appears.
- 4 Select the title to overwrite by pressing »▼« or »▲« and press »►« to open the title menu.  
– The title menu is displayed.
- 5 Select »Overwrite title« with »▼« or »▲« and press »OK« to confirm.

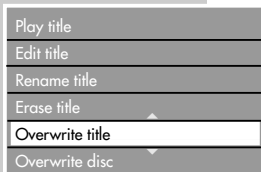
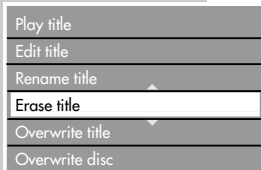

# EDITING DATA ON A DISC

- 6 Press »SOURCE« to select the input source (for example, TV).  
– Display: for example, »P1 ARD«, the current TV station is shown.
- 7 Select the television programme by pressing »▲« or »▼«.
- 8 Press »●« to start recording.  
– The available recording time is displayed.  
The recording stops automatically at the end of the title.

## Overwriting discs

This function allows you to overwrite the disc from the start to the end of the recording.

If you no longer need any of the titles on the disc, use the »Delete disc« function in the disc menu.

- 1 Put a DVD+RW or DVD-RW in the disc compartment.
- 2 Press »i« to open the main menu.
- 3 Select »► DVD« by pressing »▼« or »▲« and activate with »OK«.  
– The index screen appears.
- 4 Select any title with »▼« or »▲« and press »►« to open the title menu.  
– The title menu is displayed.
- 5 Select »Overwrite disc« with »▼« or »▲« and press »OK« to confirm.
- 6 Press »SOURCE« to select the input source (for example, TV).  
– Display: for example, »P1 ARD«, the current TV station is shown.
- 7 Select the television channel with »▲« or »▼«.
- 8 Press »●« to start recording.  
– The available recording time is displayed.  
The recording stops automatically at the end of the disc.

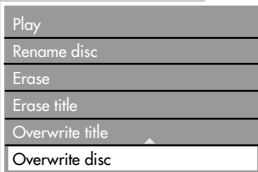



# EDITING DATA ON A DISC

## Entering the name of the disc

You can enter a name for each disc; the name is shown on the index screen.

- 1 Put a DVD+R, DVD+RW, DVD-R or DVD-RW in the disc compartment.
- 2 Press »i« to open the main menu.
- 3 Select »► DVD« by pressing »▼« or »▲« and activate with »OK«.  
– The index screen appears.
- 4 Select the disc information »MY DVD« by pressing »▼« or »▲« and activate with »►«.  
– The disc menu is displayed.
- 5 Select »Rename disc« with »▼« or »▲« and press »OK« to confirm.
- 6 Select the input field with »►« and press »▼« to activate the input keyboard.
- 7 Press »▼«, »▲«, »◀« or »▶« to select letters and numbers, and »OK« to confirm.

### Notes:

The buttons at the bottom of the keyboard are function keys: Press »cC« to switch between uppercase and lowercase. Press »BkSp« to delete a character and »Clear« to delete a word. Press »Exit« or »⏏« to quit the keyboard. Any changes are not saved.

- 8 When you have entered the new name, press »▼«, »▲«, »◀« or »▶« to switch to the »OK« button and press »OK« to confirm.  
– Display: »Updating disc... Please wait«.
- 9 Press »◀« to complete the setting.

## Deleting the content of the disc (DVD+RW/-RW)

- 1 Put a DVD-RW or DVD+RW in the disc compartment.
- 2 Press »i« to open the main menu.
- 3 Select »► DVD« by pressing »▼« or »▲« and activate with »OK«.  
– The index screen appears.

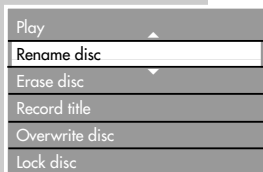

# EDITING DATA ON A DISC

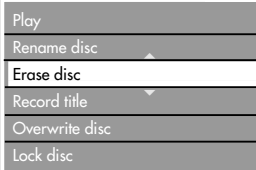

- 4 Select the disc information »MY DVD« by pressing »▼« or »▲« and activate with »▶«.  
– The disc menu is displayed.

- 5 Select »Erase disc« with »▼« or »▲« and press »OK« to confirm.

- 6 Press »OK« to delete the disc.  
– Display: »Warning: This operation will erase all data on the disc. Are you sure you want to continue?«.

## Note:

To cancel the deletion, select »No« with »OK«.

- 7 Select »Yes« with »◀« or »▶« and press »OK« to confirm.  
– Display: »Erasing ...«. You can no longer open the index screen.

## Recording titles

This function allows you to record new titles. A new title is added to the disc.

- 1 Put a DVD+R, DVD+RW, DVD-R or DVD-RW in the disc compartment.

- 2 Press »i« to open the main menu.

- 3 Select »▶ DVD« by pressing »▼« or »▲« and activate with »OK«.  
– The index screen appears.

- 4 Select the disc information »MY DVD« by pressing »▼« or »▲« and activate with »▶«.  
– The disc menu is displayed.

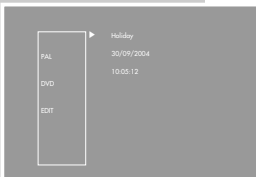

- 5 Select »Record title« with »▼« or »▲« and press »OK« to confirm.

- 6 Press »SOURCE« to select the input source (for example, TV).  
– Display: for example, »P1 ARD«, the current TV station is shown.

- 7 Select the television channel with »▲« or »▼«.

- 8 Press »●« to start recording.  
– The available recording time is displayed.  
The recording stops automatically at the end of the disc.

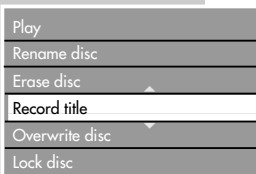

# EDITING DATA ON A DISC

## Finalising title editing

If you have edited titles or chapters, a DVD player may not be able to display this properly.

This function allows you to eliminate this problem.

If »Make compatible« does not appear in the menu, the disc is already compatible and the setting is not necessary.

- 1 Put a DVD+R, DVD+RW, DVD-R or DVD-RW in the disc compartment.
- 2 Press »i« to open the main menu.
- 3 Select »► DVD« by pressing »▼« or »▲« and activate with »OK«.  
– The index screen appears.
- 4 Select the disc information »MY DVD« by pressing »▼« or »▲« and activate with »►«.  
– The disc menu is displayed.
- 5 Select »Make compatible« with »▼« or »▲« and press »OK« to confirm.  
– Display: »Working«, followed by the index screen.  
The titles and chapters on the disc are now correctly displayed on a DVD player.

### Note:

This can take some time.

## Locking a disc

This protects the disc from being accidentally recorded over.

- 1 Put a DVD+RW or DVD-RW in the disc compartment.
- 2 Press »i« to open the main menu.
- 3 Select »► DVD« by pressing »▼« or »▲« and activate with »OK«.  
– The index screen appears.
- 4 Select the disc information »MY DVD« by pressing »▼« or »▲« and activate with »►«.  
– The disc menu is displayed.
- 5 Select »Lock disc« with »▼« or »▲« and press »OK« to confirm.  
– Display: »Working ...«, followed by the index screen.  
You can no longer record on the disc.

### Note:

To unlock the disc, select »Unlock disc« in the disc menu and press »OK« to confirm.

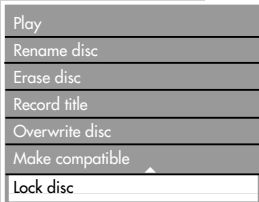
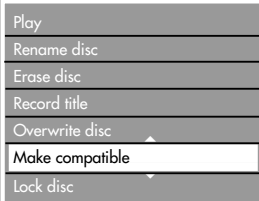
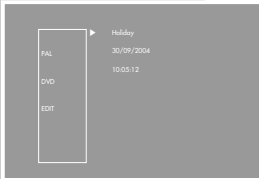

# EDITING DATA ON A DISC

## Finalising a disc (DVD+R/-R/-RW only)

If you want to play a DVD+R/-R on a DVD player, you must first finalise it. The HDD DVD recorder is able to play the unfinalised disc.

Note that after a disc is finalised, no changes or any new recordings can be made on it.

If »Finalising disc« does not appear in the menu, the disc has already been finalised or it is a DVD+RW.

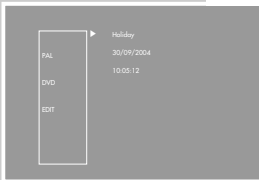

- 1 Put a DVD+R, DVD-R or DVD-RW in the disc compartment.
- 2 Press »i« to open the main menu.
- 3 Select »► DVD« by pressing »▼« or »▲« and activate with »OK«.  
– The index screen appears.
- 4 Select the disc information »MY DVD« by pressing »▼« or »▲« and activate with »►«.  
– The disc menu is displayed.
- 5 Select »Finalise disc« with »▼« or »▲« and press »OK« to confirm.  
– Display: »Working ...«, followed by the index screen.

## Deleting the content of the disc (DVD+RW/-RW)

If you cannot switch to the disc menu on a DVD+RW/-RW to delete the disc (the disc is not compatible with the HDD DVD recorder), you can delete the disc using the function in the »System Setup« menu.

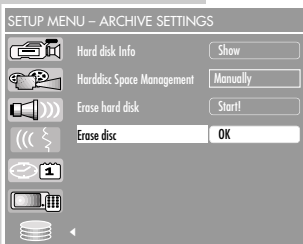

- 1 Put a DVD+RW/-RW in the disc compartment.
- 2 Press »SET UP« to open the setup menu.
- 3 Select »SETUP-MENU – ARCHIVE SETTINGS« (  ) with »▼« or »▲« and press »OK« to confirm.
- 4 Select »Erase disc« with »▼« or »▲« and press »OK« to confirm.
- 5 Press »OK« to delete the contents of the disc.  
– Display: »Warning: This operation will erase all data on the disc. Are you sure you want to continue?«.

### Note:

To cancel the deletion, select »CANCEL« and confirm with »OK«.

- 6 Select »OK« with »◀« or »▶« and press »OK« to confirm.

# EDITING DATA ON THE HDD ARCHIVE

In the »HDD archive« menu there are many options for editing the recorded programmes.

You can select titles and copy them to disc or delete or sort titles.

You can start playback in a sub-menu, delete a title, split the title in two parts, mark certain parts of the title and block their playback, change the title picture index, change the name of the title, secure the title against inadvertent deletion and prohibit playback of the title.

## Preparation

- 1 To make a copy, put a DVD+R, DVD+RW, DVD-R or DVD-RW into the disc compartment.
- 2 Press »i« to open the main menu.
- 3 Select »HDD« with »▼« or »▲« and activate with »OK«.  
– The HDD archive is displayed.

### Note:

You can also open the HDD archive by pressing »☐« (yellow).

### Note:

The rest of the process is described in the following sections, starting from step 1.



## Copying a title to disc

- 1 Select the title by pressing »▼« or »▲«.
- 2 Mark the title by pressing »☐«.  
– A status line is displayed above the index screen. This line shows the space required by the title on the disc as a graph and in percent.
- 3 Start copying the title with »●«.  
– The »●« symbol is displayed during the copying process.

### Notes:

You can mark and skip over several titles.

If the length of the title is greater than the space left on the disc, the message »DVD is full« appears.

If the length of the title is greater than the space left on the disc, the message »DVD is full« appears. To copy the title you must split it, see the section on splitting titles in two on page 79.

# EDITING DATA ON THE HDD ARCHIVE

## Deleting titles in the HDD archive

- 1 Select the title to be deleted with »▼« or »▲«.
- 2 Press »×« (red) to delete the titles.  
– Display: »Do you want to delete this title?«.
- 3 Select »Yes« with »◀« or »▶« and press »OK« to confirm.

## Sorting titles in the HDD archive

You can sort titles by recording date, recording time and title name.

- 1 Press »⌚« (green) once.  
– The »Date« display is marked.
- 2 Press »⌚« (green) to select the sort term.

## Functions in the HDD archive sub-menu

- 1 Press »i« to open the main menu.
- 2 Select »HDD« with »▼« or »▲« and activate with »OK«.  
– The HDD archive is displayed.
- 3 Select the title by pressing »▼« or »▲«.
- 4 Press »▶« to activate the selection menu.  
– The »Selection menu« is displayed.

### Playing titles

- 1 Select »Play« with »▼« or »▲« and confirm with »OK«.  
– Playback of the title starts.

### Deleting titles

- 1 Select »Delete« with »▼« or »▲« and press »OK« to confirm.  
– Display: »Do you want to delete this title?«.
- 2 Select »Yes« with »◀« or »▶« and press »OK« to confirm.

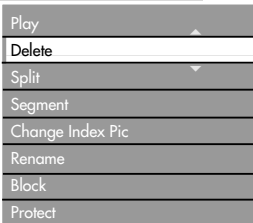
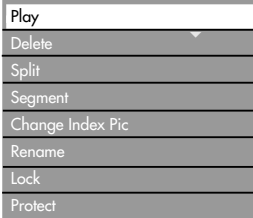

# EDITING DATA ON THE HDD ARCHIVE

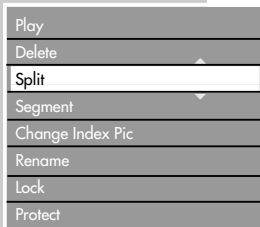

## Splitting titles in two

You can split a title into two. Afterwards you can then delete these titles separately, so that you can use the memory space on the hard disc again.

- 1 Select »Split« with »▼« or »▲« and confirm with »OK«. – Playback of the title starts.
- 2 At the scene where the title is to be split, press »OK«. – Display: »Do you want to split this title from current point?«.

### Notes:

To cancel the process, select the »CANCEL« button with »◀« or »▶« and confirm with »OK«.

- 3 Select »OK« and confirm with »OK«. – The title is split, both parts can be seen as titles in the contents table.

## Editing titles (hiding scenes)

You can bookmark several parts in a track, for example, to remove the commercial breaks.

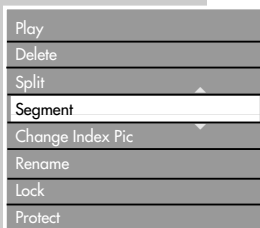

- 1 Select »Segment« with »▼« or »▲« and confirm with »OK«. – Playback of the title starts.
- 2 Search for the scene which is to be removed in playback mode or in picture search mode. Then press the »⏸« (green) button.
- 3 At the end of the scene you wish to remove, press »X« (red). – This scene is marked in red in the information bar.

### Notes:

Repeat the process as often as required for other scenes. Press »CL« to delete the markings.

- 4 Press »■« to end playback. – The contents table is displayed.

### Notes:

During playback of the title, the marked scenes will be skipped, but not deleted on the HDD archive.

When you copy the title from the HDD archive to disc the marked scenes will not be recorded over.

# EDITING DATA ON THE HDD ARCHIVE

## Creating a new index thumbnail for a title

You can select and save any scene as a new index thumbnail for the title.

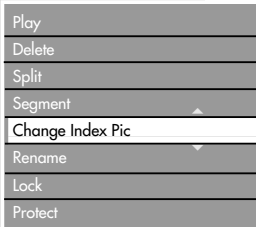

- 1 Select »Change Index Pic« with »▼« or »▲«. – Playback of the title starts.
- 2 At the scene you want to use as a new index picture, press »OK«. – Display: »Do you want to use current picture as index picture?«.

### Note:

To cancel the process, select the »CANCEL« button with »◀« or »▶« and confirm with »OK«.

- 3 Select »OK« and confirm with »OK«. – You will see the new title picture index in the contents table.

## Editing the names of recordings

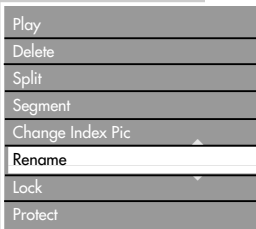

- 1 Select »Rename« with »▼« or »▲« and confirm with »OK«. – The keyboard is displayed.
- 2 Move the cursor »▲« to the title line and select the input field with »◀« or »▶«.

### Note:

With the »Clear« button you can delete the entire title name, use »BkSp« to delete individual characters.

- 3 Press »▼«, »▲«, »◀« or »▶« to select characters, and press »OK« to confirm.

### Notes:

The buttons at the bottom of the keyboard are function keys: Press »cC« to switch between uppercase and lowercase. Press »BkSp« to delete a character and »Clear« to delete a word. Press »Exit« or »[↵]« to quit the keyboard. Any changes are not saved.

- 4 When you have entered the new name, press »▼«, »▲«, »◀« or »▶« to switch to the »OK« button and press »OK« to confirm. – You will see the new name in the contents table.



# EDITING DATA ON THE HDD ARCHIVE

## Blocking playback of a title

You can only start playing back the title once you have entered a password.

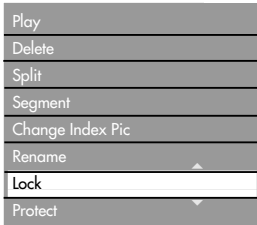

- 1 Select »Lock« with »▼« or »▲« and confirm with »OK«. – Title is blocked, »🔒« is indicated next to the title picture index.

### Note:

To undo the block, select »Unlock« with »▼« or »▲« and confirm with »OK«.

Enter the password »3 3 0 8« (or your personal password) with the numerical buttons »1...0« and confirm with »OK«.

## Protecting titles against accidental deletion and editing

This protects titles on the hard disc from being accidentally deleted.

You can only delete the title after you have removed this protection.

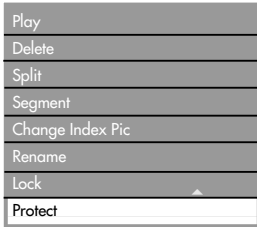

- 1 Select »Protect« with »▼« or »▲« and press »OK« to confirm. – Title is protected, »🔒« is indicated next to the title picture index.

### Note:

To remove the protection, select »Unprotect« with »▼« or »▲« and confirm with »OK«.

# EDITING DATA ON THE HDD ARCHIVE

## Viewing information via the HDD archive

This function tells you about the HDD archive memory (total memory, memory already assigned and the memory still available) and the number of titles stored.

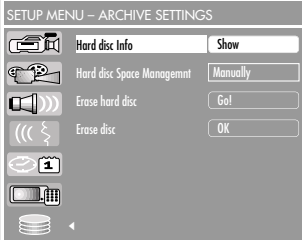

- 1 Press »**SET UP**« to open the setup menu.
- 2 Select »SETUP-MENU – ARCHIVE SETTINGS« (  ) with »▼« or »▲« and press »**OK**« to confirm.
- 3 Select »Hard disc info« with »▼« or »▲« and activate with »**OK**«.  
– The information appears.
- 4 Press »**OK**« to switch off the information.
- 5 Press »**SET UP**« to quit the menu.

## Organising the hard disc

This setting allows you to specify whether you delete old recordings automatically or manually if there is not sufficient memory for new recordings in the HDD archive.

Select »Automatically« – and the oldest recordings stored will be automatically deleted to make space for new ones.

Select »Manually« – and before new recordings can be saved, those already stored in the HDD archive are deleted manually.

### Note:

Protected recordings in the HDD archive are not deleted.



- 1 Press »**SET UP**« to open the setup menu.
- 2 Select »SETUP-MENU – ARCHIVE SETTINGS« (  ) with »▼« or »▲« and press »**OK**« to confirm.
- 3 Select »Hard disc Space Management« with »▼« or »▲« and activate with »**OK**«.
- 4 Select »Automatically« or »Manually« and press »**OK**« to confirm.
- 5 Press »**OK**« to confirm the function.
- 6 Press »**SET UP**« to quit the menu.

# EDITING DATA ON THE HDD ARCHIVE

## Deleting data in the HDD archive

This function deletes all the data in the HDD archive.

### Caution:

Even the protected recordings in the »HDD archive« are deleted.



- 1 Press »**SET UP**« to open the setup menu.
- 2 Select »**SETUP-MENU – ARCHIVE SETTINGS**« (  ) with »▼« or »▲« and press »**OK**« to confirm.
- 3 Select »Erase hard disc« with »▼« or »▲« and activate with »**OK**«.
- 4 Enter the password »**3 3 0 8**« (or your personal password) with the numerical buttons »**1...0**« and confirm with »**OK**«.
- 5 Select »**OK**« with »◀« or »▶« and press »**OK**« to confirm.  
– Display: »The contents of the hard drive are deleted«.  
»Empty« appears in the index screen in the HDD archive.

### Note:

We recommend that you pull out the plug and then plug it in again after you have deleted something.

# COPYING

## Note:

Do not connect any other equipment while the device is switched on. Switch off the other equipment as well before connecting it. Only plug the device into the mains socket after you have connected the external devices and the antenna.

## Connection and preparation

### Connecting a camcorder

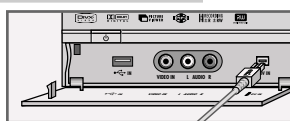
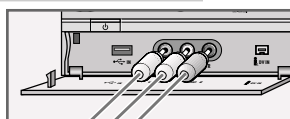
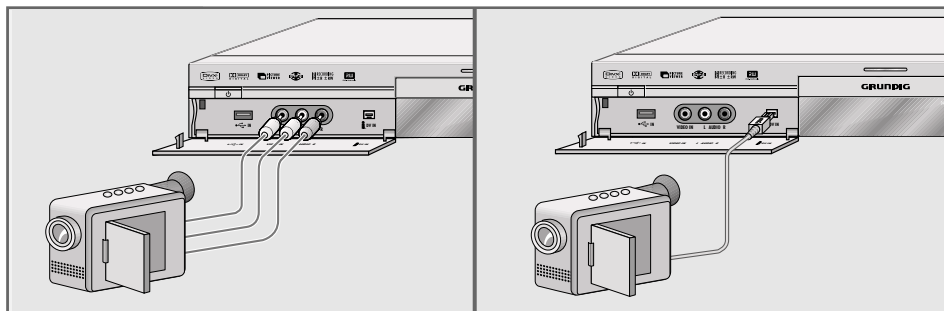

- 1 Connect the »**VIDEO IN**« and »**L AUDIO IN R**« sockets on the front of the HDD DVD recorder to the corresponding sockets on the camcorder using standard cinch cables

or

Connect the »**DV IN**« socket on the front of the HDD DVD recorder to the corresponding socket on the digital camcorder using a standard cable.

### Connecting a video recorder, DVD player or set-top box

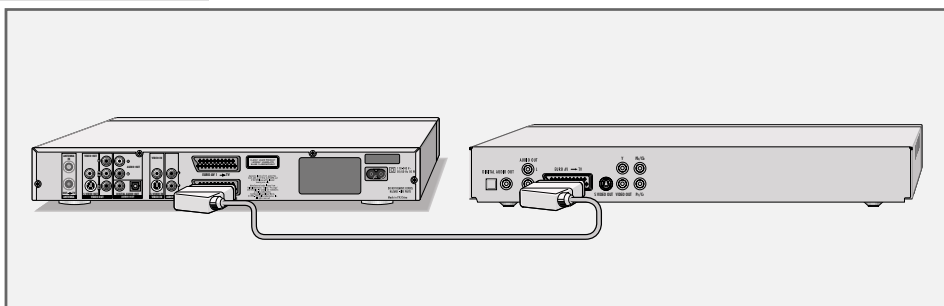

- 1 Connect the »**EURO AV2 → DECODER**« socket on the HDD DVD recorder to the corresponding socket on the video recorder, DVD player or set-top box using a standard EURO-AV (SCART) cable.

## Recording from external devices

### Preparation

Switch on the television.

Select the »AV« channel on the television for the HDD DVD recorder.

Put a DVD+R, DVD+RW, DVD-R or DVD-RW into the disc compartment.

Please select the recording quality before starting the recording. See the section on custom settings and selecting the recording quality on page 96.

### Recording

- 1 When you switch on the HDD DVD recorder, the current programme that you can see on the television screen is recorded in the time shift memory.
- 2 Select the channel on the HDD DVD recorder:  
Press »SOURCE« or »0« (AV) to select the »EURO-AV 2« channel (for a video recorder, DVD player or set-top box) or the »VIDEO IN« channel (for a camcorder), or press »DV« to select the »DV« channel (for a digital camcorder).
- 3 If the programme is to be recorded on the HDD archive, start the recording with »●«

or

if the programme is to be recorded on disc, press »⊕« (blue) to switch to disc mode, confirm with »OK« and start the recording with »●«.

#### Note:

After starting the recording, you can press »●« to enter the switch-off time (30 to 690 minutes in 30-minutes increments). The HDD DVD recorder automatically switches off the recording after this time.

- 4 Press »■« to end the recording.  
– A message appears.  
Acknowledge it with »OK«.

#### Note:

If this message is not acknowledged, the HDD DVD recorder continues the recording.

- 5 When recording onto a disc, the »YesDVD« menu appears after a short while.

#### Note:

If you wish to use the YesDVD function, please read the section on executing the YesDVD function on page 57.

If you do not wish to use the YesDVD function, select »No« with »▼« in the menu and confirm it with »OK«.

# OPERATION WITH A DECODER

## Connection and preparation

A decoder is necessary when the HDD DVD recorder receives encoded programs from a private broadcaster. Ask your dealer about the decoder.

### Connection

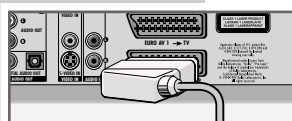
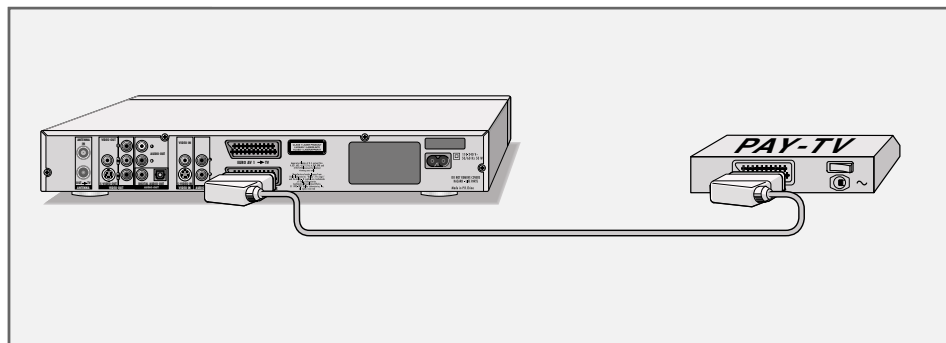

- 1 Connect the »EURO AV2 → DECODER« socket on the HDD DVD recorder to a suitable socket on the decoder using a EURO-AV (SCART) cable.

### Setting the channel position for a decoder

- 1 Open the »MAIN MENU« of the HDD DVD recorder by pressing »i«.
- 2 Select the »► DVD« menu item with »▼« or »▲« and press »OK« to confirm.
- 3 Press »SET UP« to open the setup menu.
- 4 Select »SETUP-MENU – RECORDING« (  ) with »▼« or »▲« and press »OK« to confirm.
- 5 Select »Modify Channel« with »▼« or »▲« and press »OK« to confirm.
- 6 Select »Channel number« by pressing »▼« or »▲«. Enter the preset channel for the television station which requires the decoder using the numerical buttons »1...0« and confirm with »OK«.
- 7 Select »Decoder« with »▼« or »▲« and press »OK« to confirm. Press »▼« or »▲« to select »On« and press »OK« to confirm.  
– The channel is marked in the station list with a »D« in front of its name.
- 8 Press »SET UP« to complete the setting.

Modify channel information

Channel number	P001
Name	I T V
Standard	PAL B/G
Search Type	Channel
Band	Standard
Channel	C 0 6
Fine Tuning	
Decoder	Off
Skip	OK
OK Cancel	

# USING A DECODER

## Recording pay TV programmes

### Preparation

Switch on the television.

Select the »AV« channel on the television for the HDD DVD recorder.

Put a DVD+R, DVD+RW, DVD-R or DVD-RW into the disc compartment.

Please select the recording quality before starting the recording. See the section on custom settings and selecting the recording quality on page 96.

- 1 When you switch on the HDD DVD recorder, the current programme that you can see on the television screen is recorded in the time shift memory.
- 2 Press »SOURCE« to select the input source (for example, TV).  
– Display: for example, »P1 ARD«, the current TV station is shown.
- 3 Select the required pay TV station with »▼« or »▲« or with the numerical buttons »1...0«.
- 4 If the programme is to be recorded on the HDD archive, start the recording with »●«

or

if the programme is to be recorded on disc, press »⊕« (blue) to switch to disc mode, confirm with »OK« and start the recording with »●«.

### Note:

After starting the recording, you can press »●« to enter the switch-off time (30 to 690 minutes in 30-minutes increments). The HDD DVD recorder automatically switches off the recording after this time.

- 5 Press »■« to end the recording.  
– A message appears.  
Acknowledge it with »OK«.

### Note:

If this message is not acknowledged, the HDD DVD recorder continues the recording.

- 6 When recording onto a disc, the »YesDVD« menu appears after a short while.

### Note:

If you wish to use the YesDVD function, please read the section on executing the YesDVD function on page 57.

If you do not wish to use the YesDVD function, select »No« with »▼« in the menu and confirm with »OK«.

# USB MODE

## Connection and preparation

To connect a digital camera or an external storage medium, switch the HDD DVD recorder into standby with »**U**« and switch it on only after connecting. Even if you disconnect the USB, the HDD DVD recorder must first be switched to standby, otherwise files can be damaged.

### Connecting external data devices

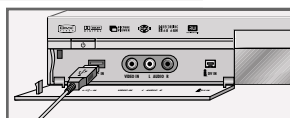
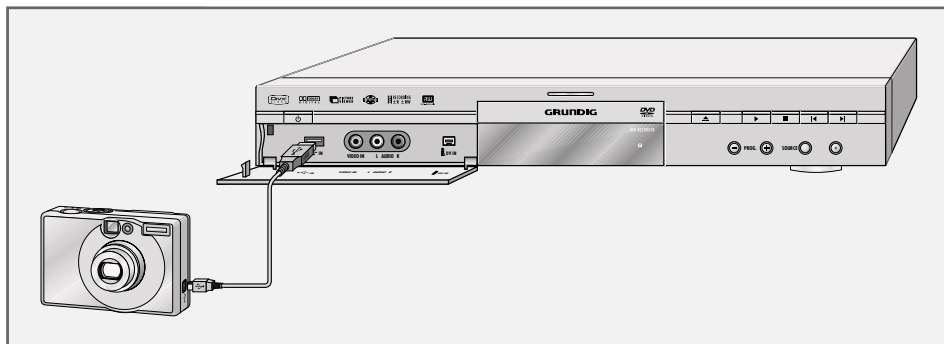

- 1 Connect the USB interface » **IN**« on the HDD DVD recorder to the corresponding socket on the data device (digital camera, card-reading device or MP3 player) using a USB cable

or

insert the USB plug of the USB memory stick into the USB interface » **IN**« on the HDD DVD recorder.

#### Note:

You can connect several devices to the USB interface » **IN**« on the HDD DVD recorder at the same time, using a USB hub.

### Preparation

Switch on the television.

Select the »AV« channel on the television for the HDD DVD recorder.

#### Note:

A bi-directional data transfer as defined for ITE (Information Technology Equipment) devices in EN 55022/EN 55024 is not possible.











USB transfer is not in itself an operating mode. It is only an additional function.



# USB MODE

## Playing back content from external data devices

### Playback



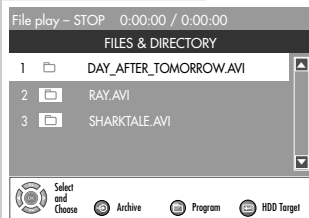











- 1 Press »« on the remote control to switch on the HDD DVD recorder from standby mode.
- 2 Press »« to open the main menu.
- 3 Select » USB« with »« or »« and press »**OK**« to activate.  
– The file browser appears.
- 4 Select the folder using »« or »« and open with »**OK**«.
- 5 Press »« or »« to select the file you want and press »**OK**« or »« to start playback.



## Creating and playing back a playlist

This function allows you to copy selected files from an external data device into a playlist and then to play back this list.

### Playback

- 1 Press »« on the remote control to switch on the HDD DVD recorder from standby mode.
  - 2 Press »« to open the main menu.
  - 3 Select » USB« with »« or »« and press »**OK**« to activate.  
– The file browser appears.
  - 4 Select the »File play« menu with »« (yellow).
  - 5 Press »« or »« to select the folder/file and use »« (green) to copy it to the »Favorite/Program«.
- Note:**  
To delete a file from the »Favorite/Program« press »«, select the file using »« or »« and delete with »« (red).
- 6 Press »« to start playback.

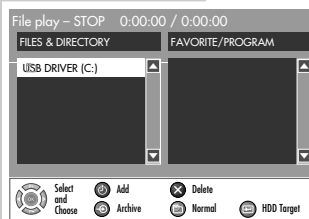

# USB MODE

## Copying content from external data devices to disc

This function allows you to copy files from an external data device onto a DVD+R/+RW or DVD-R/-RW.

DVD +RW/-RWs can be recorded on several times.

If you use DVD +R/-Rs for copying, burning is only possible once.

### Preparation

Switch on the television.

Select the »AV« channel on the television for the HDD DVD recorder.

Put a DVD+R/+RW, or DVD-R/-RW into the disc compartment.

#### Note:



There may not be any "film data" on the DVD+R/+RW or DVD-R/-RW.

Read the section on page 76 to find out how to delete the data on the disc.



### Recording

1 Press »« on the remote control to switch on the HDD DVD recorder from standby mode.





2 Press »« to open the main menu.

3 Select » USB« with »« or »« and press »**OK**« to activate.  
– The file browser appears.

4 Open »Edit menu« by pressing »« (blue).

5 Press »« or »« to select the folder/file and use »« (green) to copy.  
– The file is copied into the »Selected File List«.

#### Note:

To delete a file from the »Selected File List« press »«, select the file using »« or »« and delete with »« (red).

6 Press »« to start recording.

#### Note:

If you do not want to copy the file/folder, confirm »Cancel« by pressing »**OK**«.

7 Confirm the security query by using »« or »« to select »**OK**« and confirm with »**OK**«.

#### Note:

The HDD DVD player sets up new folders on the disc for this recording:

»D YYYY.MM.DD« (the date of creation), »T HH:MM:SS« (the time), then the folder for the files.

8 Press »« (blue) to end copying.

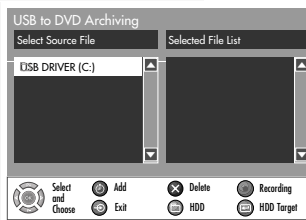

# PARENTAL LOCK

## Authorising the content of a DVD

Films on DVD may be wholly or partially unsuitable for children. These DVDs contain information which marks the content or scenes. They are assigned access levels 1 to 8, which may differ from country to country. You can select one of the access levels and a certain country, and thus authorise alternative scenes for playback.

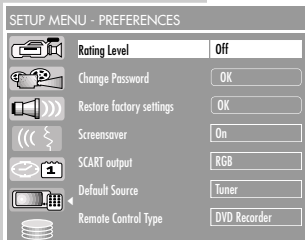

- 1 Place any disc in the tray.
- 2 Press »**SET UP**« to open the setup menu.
- 3 Select »**SETUP-MENU – PREFERENCES**« (  ) with »▼« or »▲« and press »**OK**« to confirm.
- 4 Select »**Rating level**« with »▼« or »▲« and press »**OK**« to confirm.
- 5 Press »▼« or »▲« to select the rating level and »**OK**« to confirm.
- 6 Enter the password »**3 3 0 8**« using the number buttons »**1...0**« and press »**OK**« to confirm.
- 7 Press »**OK**« to confirm.
- 8 Press »**SET UP**« to finish the setting.

## Changing the access code (password)

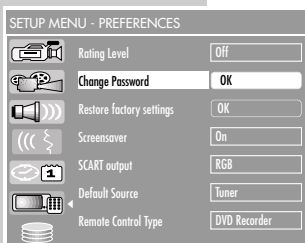



- 1 Press »**SET UP**« to open the setup menu.
- 2 Select »**SETUP-MENU – PREFERENCES**« (  ) with »▼« or »▲« and press »**OK**« to confirm.
- 3 Select »**Change Password**« with »▼« or »▲« and press »**OK**« to confirm.
- 4 Enter the code number »**3 3 0 8**« with the numerical buttons »**1...0**«.
- 5 Select »**Enter new password**« with »▼« and enter a new four-digit password with the numerical buttons »**1...0**«.
- 6 Select »**Enter new password again**« with »▼« and enter the same password again with the numerical buttons »**1...0**«.
- 7 Select »**OK**« with »▼« and confirm with »**OK**«.
- 8 Press »**SET UP**« to finish the setting.

# AUDIO SETTINGS

## Selecting the digital output

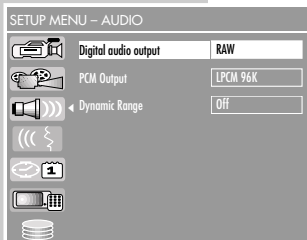
Here you select whether the audio signal is emitted from the »**DIGITAL AUDIO OUT**« socket in the original data format (All) or in PCM format (Pulse Code Modulation).





- 1 Press »**SET UP**« to open the setup menu.
- 2 Select »SETUP-MENU – AUDIO« (  ) with »▼« or »▲« and press »**OK**« to confirm.
- 3 Select »Digital audio output« with »▼« or »▲« and press »**OK**« to confirm.
- 4 Select the mode (»RAW« or »LPCM«) by pressing »▼« or »▲« and press »**OK**« to confirm.
- 5 Press »**SET UP**« to finish the setting.

## Setting the sampling rate

This setting is used to adjust the sampling rate of the digital output. The sampling rate indicates how many samples can be read in per time interval.

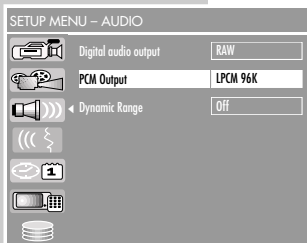
- Use »96 K« for DVDs with a 96 kHz audio signal for optimum analogue audio output at the »**L AUDIO OUT R**« sockets.
- Use »48 K« for DVDs with a 48 kHz audio signal. The signal is emitted at the »**L AUDIO OUT R**« and »**DIGITAL AUDIO OUT**« sockets.



- 1 Press »**SET UP**« to open the setup menu.
- 2 Select »SETUP-MENU – AUDIO« (  ) with »▼« or »▲« and press »**OK**« to confirm.
- 3 Select »PCM Output« using »▼« or »▲« and press »**OK**« to confirm.
- 4 Select the value (»LPCM 48 K« or »LPCM 96 K«) with »▼« or »▲« and confirm with »**OK**«.
- 5 Press »**SET UP**« to finish the setting.

# AUDIO SETTINGS

---

## Switching the dynamic range (volume range) on and off

Dolby digital soundtracks have a very large dynamic volume range, hence there is a great difference in volume between quiet and loud tones. The dynamic range function optimises this at low volume.

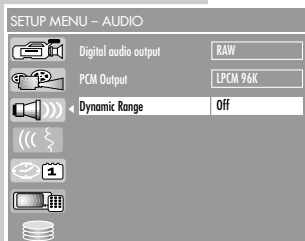

- 1 Press »**SET UP**« to open the setup menu.
- 2 Select »SETUP-MENU – AUDIO« (  ) with »▼« or »▲« and press »**OK**« to confirm.
- 3 Select »Dynamic Range« with »▼« or »▲« and press »**OK**« to confirm.
- 4 Select »ON« or »OFF« with »▼« or »▲« and confirm with »**OK**«.
- 5 Press »**SET UP**« to finish the setting.

# CUSTOM SETTINGS

## Language settings



You can choose between various languages.

- 1 Press »**SET UP**« to open the setup menu.
- 2 Select »**SETUP-MENU – LANGUAGE**« (  ) with »▼« or »▲« and press »**OK**« to confirm.

### Note:

The rest of the process is described in the following sections, starting from step 1.

### Selecting the dubbing language

If several languages are available on the current DVD, the sound is played back in the language you have selected.

If the language you select is not on the DVD, the HDD DVD recorder automatically selects the first audio language available.

- 1 Select »**Audio Language**« with »▼« or »▲« and press »**OK**« to activate it.
- 2 Select your language using »▼« or »▲« and press »**OK**« to confirm.



### Selecting the language for the subtitles

If subtitles are available on the current DVD, they are shown in the language you have selected.

If the language you have selected for the subtitles is not on the DVD, the HDD DVD recorder automatically selects the first language available.

- 1 Select »**Subtitle Language**« by pressing »▼« or »▲« and press »**OK**« to confirm.
- 2 Select your language using »▼« or »▲« and press »**OK**« to confirm.



### Selecting the language of the DVD menus

If the DVD has menus in several languages, you can select your language of choice.

- 1 Select »**Disc menu language**« with »▼« or »▲« and press »**OK**« to confirm.
- 2 Select the language for the DVD menus using »▼« or »▲« and press »**OK**« to confirm.

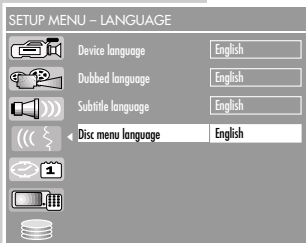

### Finishing the settings

- 1 Press »**SET UP**« to finish the setting.

# CUSTOM SETTINGS

## Switching the screen saver on and off

When this function is activated, the screen saver starts when no function has been selected on the HDD DVD recorder for some time.

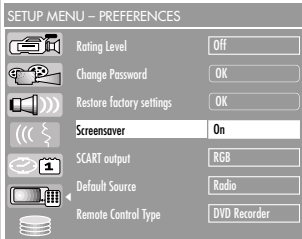



- 1 Press »**SET UP**« to open the setup menu.
- 2 Select »**SETUP-MENU – PREFERENCES**« (  ) with »▼« or »▲« and press »**OK**« to confirm.
- 3 Select »**Screensaver**« with »▼« or »▲« and press »**OK**« to confirm.
- 4 Select the function with »▼« or »▲« (»**ON**« or »**OFF**«) and confirm with »**OK**«.
- 5 Press »**SET UP**« to finish the setting.

## Setting the signal type for the video output socket

The video output of your HDD DVD recorder was set at the factory to »**RGB**«.

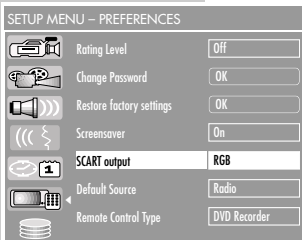
If you connect your HDD DVD recorder to a television, flat screen or projector using cinch cables (»**Y**«, »**Pb/Cb**« and »**Pr/Cr**« of the HDD DVD recorder), you must set the video output correctly so that the television receives the video signal and therefore the picture.



- 1 Press »**SET UP**« to open the setup menu.
- 2 Select »**SETUP-MENU – PREFERENCES**« (  ) with »▼« or »▲« and press »**OK**« to confirm.
- 3 Select »**SCART output**« with »▼« or »▲« and press »**OK**« to confirm.
- 4 Select the video output with »▼« or »▲« and press »**OK**« to confirm.
  - »**RGB**« for the »**EURO AV1 → TV**« socket,
  - »**YUV**« for the sockets »**Y**«, »**Pb/Cb**« and »**Pr/Cr**«,
  - »**Y/C**« for the »**EURO AV1 → TV**« sockets or »**S-VIDEO OUT**«.
  - »**Video**« for the »**EURO AV2 → TV**« or »**VIDEO OUT**« sockets.
- 5 Press »**SET UP**« to finish the setting.

### Notes:

The »**YUV**« setting is a precondition for interlace and progressive mode. If it has been selected, you can use »**I/P**« to switch between the two output formats. You can also do this using the setup menu.

In progressive mode the »**VIDEO OUT**« and »**S-VIDEO OUT**« sockets are switched off.

# CUSTOM SETTINGS

## Inserting chapter markers in recordings

This function allows you to specify whether and how often chapter markers are automatically set during recording.

- 1 Press »**SET UP**« to open the setup menu.
- 2 Select »**SETUP-MENU – RECORDING**« (  ) with »▼« or »▲« and press »**OK**« to confirm.
- 3 Select »**Auto Chapter Marker**« with »▼« or »▲« and press »**OK**« to confirm.
- 4 Press »▼« or »▲« to select the marker sequence and »**OK**« to confirm.

### Note:

If you do not want to set any chapter markers, repeat the setting and select »Off«.

- 5 Press »**SET UP**« to finish the setting.



## Selecting the recording quality

The function allows you to select the recording quality (e.g. SP).

- 1 Press »**SET UP**« to open the setup menu.
- 2 Select »**SETUP-MENU – RECORDING**« (  ) with »▼« or »▲« and press »**OK**« to confirm.
- 3 Select »**Recording Quality**« with »▼« or »▲« and press »**OK**« to confirm.
- 4 Select the recording quality using »▼« or »▲« and press »**OK**« to confirm.
- 5 Press »**SET UP**« to finish the setting.



## Selecting the input source for recording

This function allows you to select the input source (e.g. Tuner for recording TV programmes).

- 1 Press »**SET UP**« to open the setup menu.
- 2 Select »**SETUP-MENU – PREFERENCES**« (  ) with »▼« or »▲« and press »**OK**« to confirm.
- 3 Select »**Default Source**« with »▼« or »▲« and press »**OK**« to confirm.
- 4 Select the input source with »▼« or »▲« and press »**OK**« to confirm.
- 5 Press »**SET UP**« to finish the setting.

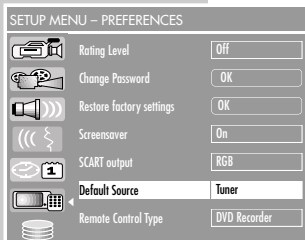



# SPECIAL SETTINGS

## Tuning television channels automatically

- 1 Open the »MAIN MENU« of the HDD DVD recorder by pressing »i«.
- 2 Select the » TimeShift« menu item with »▼« or »▲« and press »OK« to confirm.
- 3 Press »SET UP« to open the setup menu.
- 4 Select »SETUP-MENU – RECORDING« (  ) with »▼« or »▲« and press »OK« to confirm.
- 5 Select »Scan Channels« with »▼« or »▲« and press »OK« to confirm.  
– A security query is displayed.
- 6 Select »Ok« and confirm with »OK«.  
– The HDD DVD recorder searches all channels for television stations, then sorts and saves them. The automatic search may take several minutes.



### Note:

You can stop the search by pressing »■«.

## Tuning television channels manually

If you have information on a new TV station, you can tune to it manually in this menu.

- 1 Open the »MAIN MENU« of the HDD DVD recorder by pressing »i«.
- 2 Select the » TimeShift« menu item with »▼« or »▲« and press »OK« to confirm.
- 3 Press »SET UP« to open the setup menu.
- 4 Select »SETUP-MENU – RECORDING« (  ) with »▼« or »▲« and press »OK« to confirm.
- 5 Select »Modify Channel« with »▼« or »▲« and press »OK« to confirm.
- 6 Press »1...0« to enter the channel.
- 7 To change or enter the name of the TV station, select »Name« with »▼« or »▲« and press »OK« to confirm.  
Select the input position with »◀« or »▶«, enter letters or numbers with »▼« or »▲« and press »OK« to confirm.
- 8 To change the colour system, select »Standard« with »▼« or »▲« and press »OK« to confirm.  
Select the colour system with »▼« or »▲« and press »OK« to confirm.

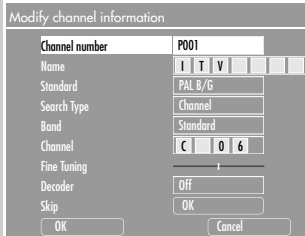
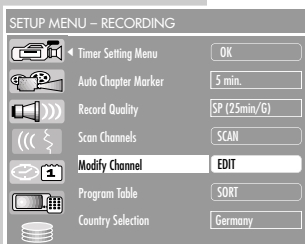

# SPECIAL SETTINGS

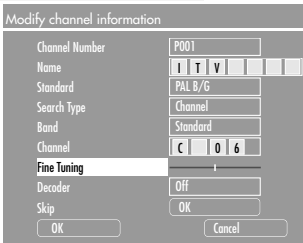
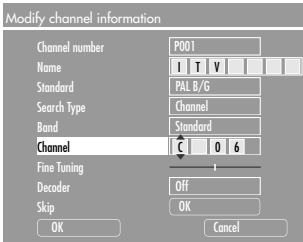
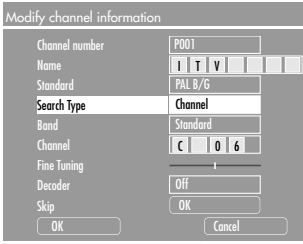

- 9 To enter the channel number or frequency of the TV station, select »Search Type« with »▼« or »▲« and press »OK« to confirm.  
Select the search parameter with »▼« or »▲« and press »OK« to confirm.
- 10 Select »Band« to set the antenna signal the HDD DVD receives. If the HDD DVD recorder is connected to a terrestrial antenna, select the »Standard« setting. If it is connected to a cable system, select the »Cable« setting.  
Select »Band« by pressing »▼« or »▲« and confirm with »OK«.  
Make the setting with »▼« or »▲« and press »OK« to confirm.
- 11 Select »Channel« or »Frequency« (depending on the setting in step 9) with »▼« or »▲« and press »OK« to confirm.  
– The cursor is positioned at the first input field.
- 12 Enter channel number:  
Press »▼« or »▲« to choose between »S« (special channel) and »C« (channel).  
Press »▶« to switch to the next input position and select »▼« or »▲« to switch up and down the channel numbers. Repeat this for the second position.  
Press »OK« to confirm your entry  
  
or  
  
enter frequency:  
Enter the frequency in five digits with »▼« or »▲«. Press »▶« to go to the next space.  
Press »OK« to confirm your entry.
- 13 To fine-tune the picture, select »Fine Tuning« with »▼« or »▲«.  
Set the picture with »◀« or »▶«.
- 14 If you want to skip a channel when using the »▼« and »▲« buttons, select »Skip« with »▼« or »▲« and press »OK« to confirm.  
Press »▼« or »▲« to select »Yes« and press »OK« to confirm.  
– The channel is marked in the station list with a »-« in front of its number.
- 15 Select »OK« with »▼« and confirm with »OK«.

**Note:**

Set further television stations by repeating steps 6 to 15.

- 16 Press »SET UP« to complete the setting.

# SPECIAL SETTINGS

## Setting the time and date

If you do not want to use the date and time broadcast by a television station, you can set it manually.

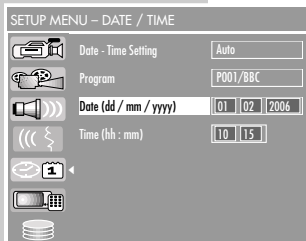

- 1 Press »**SET UP**« to open the setup menu.
- 2 Select »SETUP-MENU – DATE/TIME« (  ) with »▼« or »▲« and press »**OK**« to confirm.
- 3 Select »Date« with »▼« or »▲« and press »**OK**« to confirm.  
Enter the date in six digits with »**1...0**« and press »**OK**« to confirm.
- 4 Select »Time« with »▼« or »▲« and press »**OK**« to confirm.  
Enter the time in four digits with »**1...0**« and press »**OK**« to confirm.
- 5 Press »**SET UP**« to complete the setting.

## Switching the HDD DVD recorder to another Grundig remote control

You can adjust the HDD DVD recorder so that it can be operated with a remote control from another Grundig device.

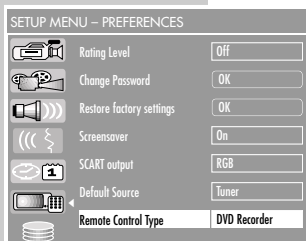

- 1 Press »**SET UP**« to open the setup menu.
- 2 Select »SETUP-MENU – PREFERENCES« (  ) with »▼« or »▲« and press »**OK**« to confirm.
- 3 Select »Remote Control Type« with »▼« or »▲« and press »**OK**« to activate.
- 4 Select the remote control type with »▼« or »▲« and press »**OK**« to confirm.  
– The HDD DVD recorder can now be operated with another remote control. The HDD DVD recorder no longer responds to its own remote control.
- 5 Press »**SET UP**« to complete the setting.

### Note:

If you want to operate the HDD DVD recorder with its own remote control again, you have to open the main menu with »▶|« (press and hold down) on the device. Activate the setup menu using the menu buttons (»|◀«, »▶|«, »**PROG +**«, »**PROG -**« and »■«) on the device and set the remote control type to »HDD DVD recorder«.

# SPECIAL SETTINGS

## DivX® Video registration

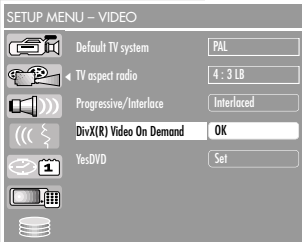

- 1 Press »**SET UP**« to open the setup menu.
- 2 Select »SETUP-MENU – VIDEO« ( ) with »▼« or »▲« and press »**OK**« to confirm.
- 3 Select »DIVX (R) Video On Demand« with »▼« or »▲« and activate with »**OK**«. – The menu shows the registration code for the internet.
- 4 Press »**SET UP**« to exit the menu.

## Resetting the HDD DVD recorder to its original condition

All custom settings are restored to the original status.

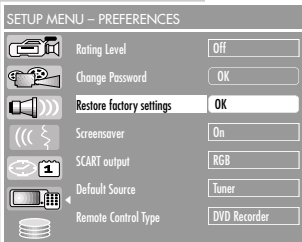

- 1 Press »**SET UP**« to open the setup menu.
- 2 Select »SETUP-MENU – PREFERENCES« ( ) with »▼« or »▲« and press »**OK**« to confirm.
- 3 Select »Restore factory settings« with »▼« or »▲« and press »**OK**« to confirm.
- 4 Select »**OK**« with »◀« or »▶« and press »**OK**« to confirm.
- 5 Press »**SET UP**« to finish the setting.



## Technical data

This product fulfils the European directives 89/336/EEC, 73/23/EEC and 93/68/EEC. This device conforms to the safety regulation DIN EN 60065 (VDE 0860) and thereby the international safety regulation IEC 60065.

Never open up the HDD DVD recorder. The manufacturer will not accept any liability for damage resulting from improper handling.

### Mains voltage:

110 – 240 V ~, 50/60 Hz

### Power consumption:

Operation: approx. 50 W  
Standby: ≤ 4 W

### Ambient temperature:

+10 °C to +35 °C

### Playback standard:

PAL, 50 Hz, 625 lines  
NTSC, 60 Hz, 525 lines

### Disc formats:

DVD+R, DVD+RW, DVD-R, DVD-RW

### Media formats:

DVD-Video, audio CD,  
video CD (VCD 1.0/1.1/2.0), S-Video CD,  
CD ROM (DivX<sup>®</sup>Video, MP3, WMA, JPEG,  
Kodak Picture CD)  
DVD ROM (DivX<sup>®</sup>Video, MP3, WMA, JPEG,  
Kodak Picture CD)

### HDD archive:

160 GB / 5400 rpm/ 2M Buffer

### Laser:

Semiconductor laser  
Wavelength 650 nm for DVD  
Wavelength 780 nm for CD

### Audio format:

Digital: MPEG2/Dolby Digital, PCM, DTS,  
MP3, WMA  
Analogue: Stereo sound, Dolby Pro Logic

### Audio:

Signal:	Analogue
DVD:	48/96 kHz      4 Hz-22/44 kHz
Video CD:	44.1 kHz      4 Hz-20 kHz
Audio CD:	44.1 kHz      4 Hz-20 kHz

Signal-to-noise ratio  
(at 1 kHz): ≥ 90 dB  
Sound volume  
(at 1 kHz): ≥ 85 dB

### Dimensions and weight:

Dimensions  
W x H x L 430 x 55 x 320 mm  
Weight 4.5 kg

# INFORMATION

---

CLASS 1  
LASER PRODUCT



## General information on laser devices

Your system is a CLASS 1 LASER PRODUCT. This means that the laser is designed in such a way as to ensure that the maximum permissible emission value cannot be exceeded under any circumstances.

### Caution:

This device emits laser radiation. Because of the danger of eye injuries, the unit may only be opened or serviced by trained personnel.

If settings other than those specified here are employed or other procedures are carried out, this may lead to dangerous radiation exposure.

This product contains components which are covered by certain U.S. patents or for other reasons are considered intellectual property of the Macrovision Corporation and other proprietors. Use of this protected technology must be approved by the Macrovision Company and is only permissible for private presentation at home or for other limited applications, where no special permission has been granted by Macrovision. Reproduction or disassembly of the device is prohibited.

Manufactured with permission from Dolby Laboratories. The "Dolby" label and the double-D logo "DD" are trademarks of Dolby Laboratories. Confidential unpublished material.  
©1992-1997 Dolby Laboratories, Inc. All rights reserved.

During playback of DTS-coded CDs and DVDs, a high noise level is produced at the analogue stereo outputs. In order to avoid damaging the audio system, always take appropriate preventive measures when connecting the stereo outputs of the HDD DVD recorder to an amplification system. For DTS Digital Surround playback, an external 5.1-channel DTS Digital Surround decoder must be connected to the digital output (S/PDIF) of the HDD DVD recorder.

DTS and DTS Digital Out are trademarks of Digital Theater Systems, Inc. All rights reserved.

YesDVD is a trademark of YesVideo, Inc. All rights reserved.

## Troubleshooting

Not every picture or sound problem is caused by a defect in your HDD DVD recorder. Impairment can also be caused by leads having been accidentally pulled out, damaged DVDs/CDs and worn-out batteries in the remote control.

If the following measures do not rectify the problem, consult an authorised dealer.

Problem	Possible cause/remedy
The HDD DVD recorder does not respond to the remote control recorder.	Point the remote control directly at the HDD DVD recorder.
	Remove all obstacles which may interfere with the path of the remote control signal.
	Check or replace the remote control batteries.
	Check whether the recorder has been set to operate with a different remote control.
The disc compartment does not open, Picture/sound problems.	Pull the mains cable plug of the HDD DVD recorder out of the socket and plug it in again.
No picture Distorted picture	Check the video connection.
	Make sure that there are no fingerprints on the DVD/CD, follow the cleaning instructions on the next page.
The DVD/CD cannot be played	Check if the label on the DVD/CD is facing upwards.
	Clean the DVD/CD.
	Check if the DVD/CD is damaged by testing out another DVD/CD.
No sound	Check the volume setting.
	Check the audio connections.
	Try another playback source.
	Use an external decoder for DTS audio formats.
No sound at the digital output	Select the "RAW" mode, see setting on page 92.
Distorted sound from the hi-fi system	Make sure that the audio connections are not connected to the phono input on the amplifier.
Recording from TV stations not possible.	Antenna cable not connected, please connect it.
	The TV station is not tuned on the HDD DVD recorder. Tune the television station.
	The selected TV channel has copy protection.
	Station not transmitting or antenna defective.
Timer recording was not performed.	The HDD DVD recorder was not switched off after timer programming.
	The VPS/PDC time was incorrectly entered for VPS/PDC-programmed recordings.
Copying from the USB port is not possible	There is "film data" on the DVD+R/+RW, please delete it.
At the end of the recording the YesDVD function is not provided.	Use a new or empty disc.
Forgotten password.	Go to the SETUP menu → PREFERENCES → Change password. Enter the password 8600 and then enter your new password.

# INFORMATION

---

Problem	Possible cause/remedy
Disc drive noises during HDD archive playback.	The inserted disc continues to rotate for approx. ten minutes before switching off. Press »▲« and remove the disc from the disc compartment.
The HDD DVD recorder does not work with the buttons on the recorder or with the remote control.	Press »⏻« on the remote control and hold down for five seconds. The HDD DVD recorder is initialised again. No data is lost from the HDD archive.



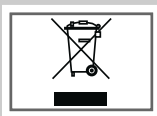

## Environmental note

This product has been made from high-quality parts and materials which can be re-used and recycled.

Therefore, do not throw the product away with normal household waste at the end of its life. Take it to a collection point for recycling electrical and electronic devices. This is indicated by this symbol on the product, in the operating manual and on the packaging.

Please find out about collection points operated by your local authority.

Help protect the environment by recycling used products.

## Cleaning discs

Wipe the dirty disc with a cloth from the centre outwards in a straight line.

Do not use any solvents such as benzene, thinners, conventional cleaner or anti-static spray for vinyl records.

Do not use a cleaning CD, as it might damage the laser of your HDD DVD recorder.

## Software information

We wish to point out explicitly that only operating software authorised by GRUNDIG is permissible for the HDD DVD recorder. This operating software is available from specialist dealers or will be available shortly on the Grundig websites [www.grundig.com](http://www.grundig.com) and [www.grundig.de](http://www.grundig.de). Any instance of operating software from a dubious Internet source being loaded to the device will impair functioning and also, since it is an unauthorised intervention, invalidate any claims under the guarantee.

GRUNDIG will refuse to refund any costs resulting in such cases. Any repair costs in such cases, even those occurring within the guarantee period, are to be paid by the customer.

# INFORMATION

## Additional Information for units sold in the UK.

Units sold in the UK are suitable for operation from a 240V ac, 50Hz mains supply.

The range of multi-system receivers is built to work in most European countries. However, the mains plug and socket system for the UK differs from many European countries.

This appliance has been supplied with a fitted, non-removable, approved converter plug for use in the UK. This converter plug is fitted with a 5A rated fuse.

In case this appliance is supplied with a moulded 2-pin Euro plug only, which is unsuitable for UK operation, this must be cut off and immediately disposed of. An approved 13A, 3-pin UK plug should then be fitted by a qualified electrician.

### Note:

The severed Euro plug must be destroyed to avoid a possible shock hazard should it be inserted into a socket elsewhere.

If a non-rewireable 3-pin plug or a rewireable 13A (BS1363) 3-pin plug is used, it must be fitted with a 5A ASTA or BSI approved BS1362 fuse. If any other type of plug is used it must be protected by a 5A fuse either in the plug, or at the distribution board. If this type of plug becomes defective, ensure that the fuse is removed before disposal, to eliminate potential shock hazard.

If it is necessary to change the fuse in the non-rewireable plug, the correct type and rating (5A ASTA or BSI approved BS1362) must be used and the fuse cover must be refitted. If the fuse cover is lost or damaged, the lead and plug must not be used until a replacement is obtained. Replacement fuse covers should be obtained from your dealer.

### Important:

The wires in the mains lead are colour coded in accordance with the following code:

BLUE – NEUTRAL

BROWN – LIVE

As the colours of the wires in the mains lead of your appliance may not correspond with the coloured marking identifying terminals in your plug, proceed as follows:

Connect the BLUE coloured wire to plug terminal marked with the letter "N" or coloured black.

Connect the BROWN coloured wire to the plug terminal marked with the letter "L" or coloured red.

In no circumstance must any of the wires be connected to the terminal marked with the letter "E", earth symbol "⏏", coloured green, or green & yellow.

